

HVACPAC 2013, 2014, 2015 & 2016 USER MANUAL

Getting started from the HVACPAC Ribbon:-

Tips:

- 1) Set your cansoscale system variable to your required plot scale to make HVACPAC work correctly.
- 2) After an in-line duct fitting or piece of equipment has been created in the editing session the user can press enter or space and the software will continue with the straight duct section connected to the HVACPAC entity created.

Ducting :-

Fittings :-



Fittings



- Straight duct sections

When the user selects this icon from the ribbon he/she will be prompted with the following question :-

Select existing object or Enter to start !!!

If there is an existing duct or equipment object previously drawn by HVACPAC the user can click onto the object and the software will automatically continue with the selected objects properties, size and direction.

If the user presses Enter then the software will prompt them for the following information:-

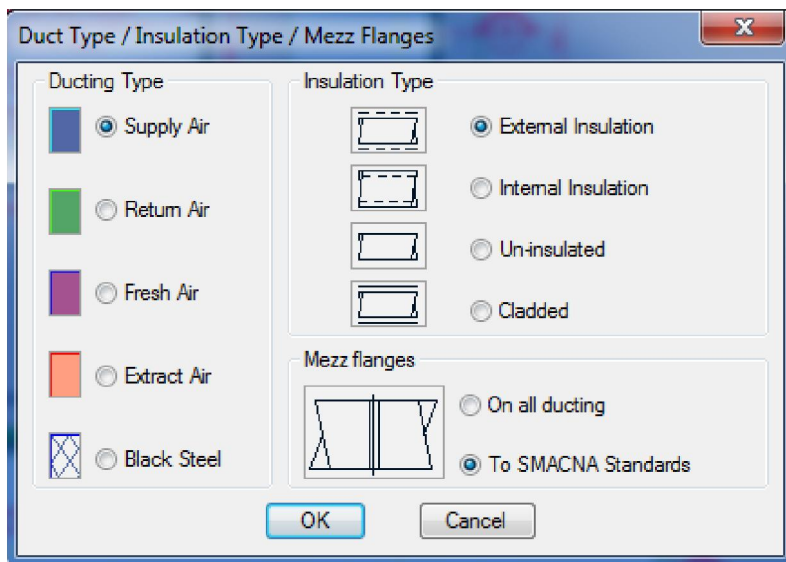

Dialog Type A

The user can choose the duct type, type of insulation and what type of duct flanges are to be shown by picking one of the radio buttons as shown above. Once selected the choices remain as the default for the rest of the editing session.

Once selected and the OK button pressed the size, angle and elevation dialog appears :-

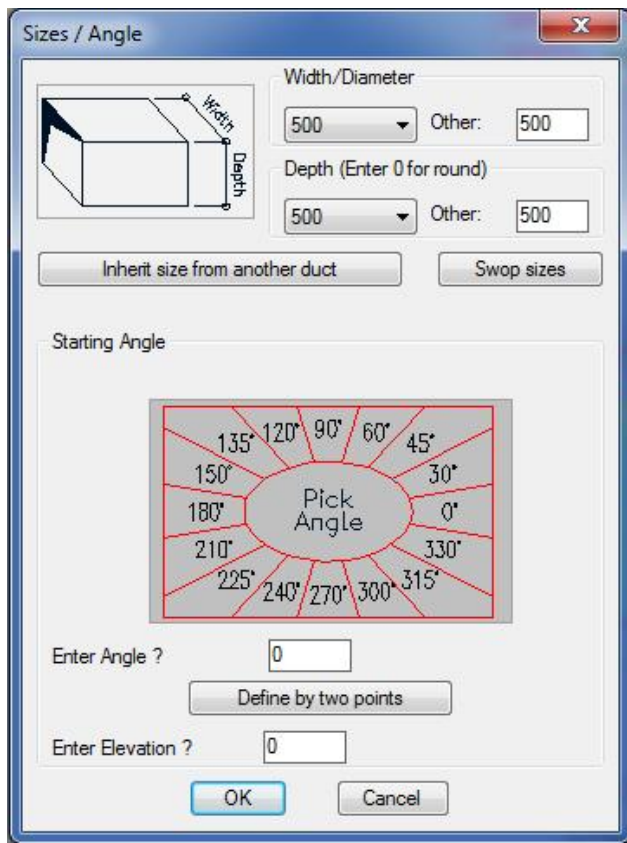

Dialog Type B

The user enters the duct fitting size either by the pull down or entering the Other : sections of the dialog. If an existing HVACPAC object is present in the drawing and the user wants to use its size he/she can simply click on the Inherit size from an existing duct to achieve this. To change the duct width to the depth and visa versa simply click on the Swop sizes button.

Note: To draw round ducting the duct depth value must be entered as 0. The width value will then be used as the diameter of the duct.

To select the required angle:-

- a) Click on the angle you desire as shown on the dialog image or
- b) Enter the angle in the box supplied or
- c) If the angle is an unknown you can use the Define by two points button to determine the actual angle you need.

Only when drawing in the 3D mode do you need to set the elevation (Default is 0)

As per Dialog Type A once set the values are retained as the default through the editing session.

On selecting OK the dialog closes and the user is prompted in the command line with :-

Centre line start point:

Here the user must indicate the start location point on the drawing screen by moving the cursor and picking a point using the osnap command. Once selected the user is again prompted in the command line with :-

Ducting centre line end point:

Here the user can either drag the cursor to the desired location and pick the desired point or he/she can enter the required distance the duct needs to cover. The duct will then be drawn with segment lengths, colours and layers as setup in the configuration section (Explained later in this user manual)

Note: Any inline fitting can then be selected off the ribbon to continue with this run or the user can end the program and start a new duct run by using the icons on the ribbon.

Tip: If the user wants a duct section that is longer than the segment lengths set up in the configuration section he can type 0 for the length and will then be prompted to enter a required length.



- Duct transformation

As per the duct section the user will be prompted with the same question:-

Select existing object or Enter to start !!!

Follow the same steps in Dialog Type A and Type B and select the centre line start point.

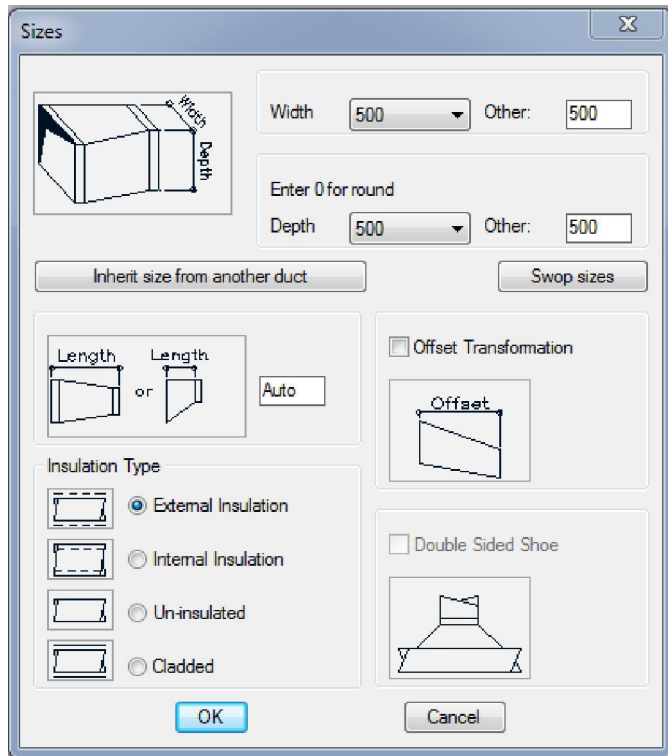

Dialog Type C

The dialog above will appear when the start point has been determined. Here the user can input the size of the new duct. As per the duct section if an existing HVACPAC object is present in the drawing and the user wants to use its size he/she can simply click on the Inherit size from an existing duct to achieve this. To change the duct width to the depth and visa versa simply click on the Swop sizes button.

The transformation length will be calculated to the SMACNA standards if left in the Auto mode. If the user requires a set length then he/she can enter the required transformation length in the box provided.

If the insulation of the new duct size needs to be different to the previous duct size the user can change this by clicking on the radio button associated with the type of insulation required.

To have an offset transformation the user simply clicks the tick box for offset transformation and is then asked to indicate the offset point.

The Double Sided shoe is greyed out in the transformation mode because it will be used when the user is creating duct shoes.

Once all the information for the new duct is entered the user clicks on the OK button to proceed.

If the new duct width is different to the old duct width then a new prompt will appear as shown

Indicate which side to transform to <M>

Here the user can either a) hit the enter button to transform to the middle b) click on the left side of the duct to transform flat on the left side or c) click on the right side of the duct to transform flat on the right side

If the new duct depth is different to the old duct depth then the following dialog is displayed

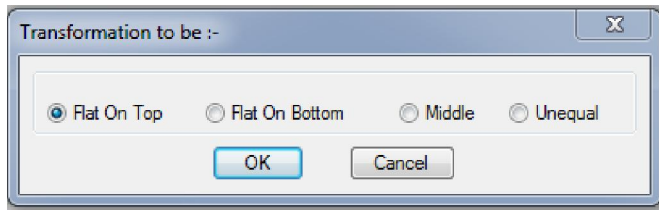

The user can then select the desired type of transformation and then click on the OK button.

The transformation will then be drawn with colours and layers as setup in the configuration section (Explained later in this user manual)

The program will pause and await the users interaction to position the text describing the type of transformation (FOT, FOB, MID or UEQ)

Note: If the user clicks on an existing duct run the software will use that ducts settings such as Type, size, direction, etc and the user will then be presented with dialog Type C to continue.



- Duct take-off shoe

This command can only be used if there is an existing duct present in the editing session. Once selecting this option from the ribbon a similar dialog box as per Dialog Type C will be displayed

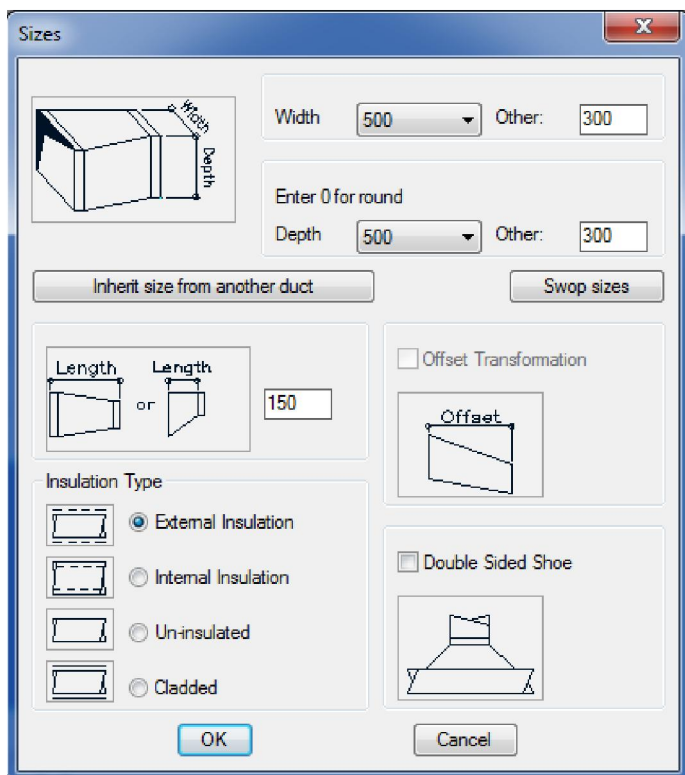

Dialog Type D

Note though this time the Offset transformation is greyed out and the Double sided shoe becomes available.

As per the transformation the user can select size, length and insulation type.

The user can also now use the double sided shoe if desired.

Once all the information for the new duct is entered the user clicks on the OK button to proceed.

Note if the user enters a new shoe depth greater than the existing duct depth then a warning dialog box is displayed

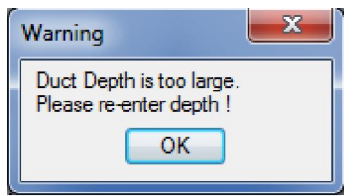

On clicking OK the user is taken back to Dialog Type D where he must re-enter the correct duct depth.

Once satisfied the following prompt will appear and ask the user on which duct to attach to.

Indicate duct to attach to:

Here the user must click on the existing duct. Note it is important to click on the existing duct on the side that you want the shoe to be placed. Once indicated the following prompt is displayed

Position shoe on duct in required horizontal location

The user can now drag or enter a distance to position the new shoe onto the horizontal face of the existing duct.

If the 3D mode is set to yes in the configuration section (Explained later in this user manual) and the new shoe depth is less than the existing duct depth then the user will be prompted

Position shoe on duct in required vertical location

Once again the user can now drag or enter a distance to position the new shoe onto the vertical face of the existing duct.

When the shoe is successfully located on the existing duct the user can click on the either the return or enter buttons to continue with the new duct run.

Tip: The shoe can be placed onto the side of a riser or plenum duct and shown in the plan view by clicking on an existing riser or plenum instead of an existing duct .



- Duct bend

As per the duct section the user will be prompted with the same question:-

Select existing object or Enter to start !!!

Follow the same steps in Dialog Type A and Type B and select the centre line start point. Or click on an existing HVACPAC entity and the software will use that entities settings such as Type, size, direction, etc .

The following dialog will appear requesting user input for the type of bend

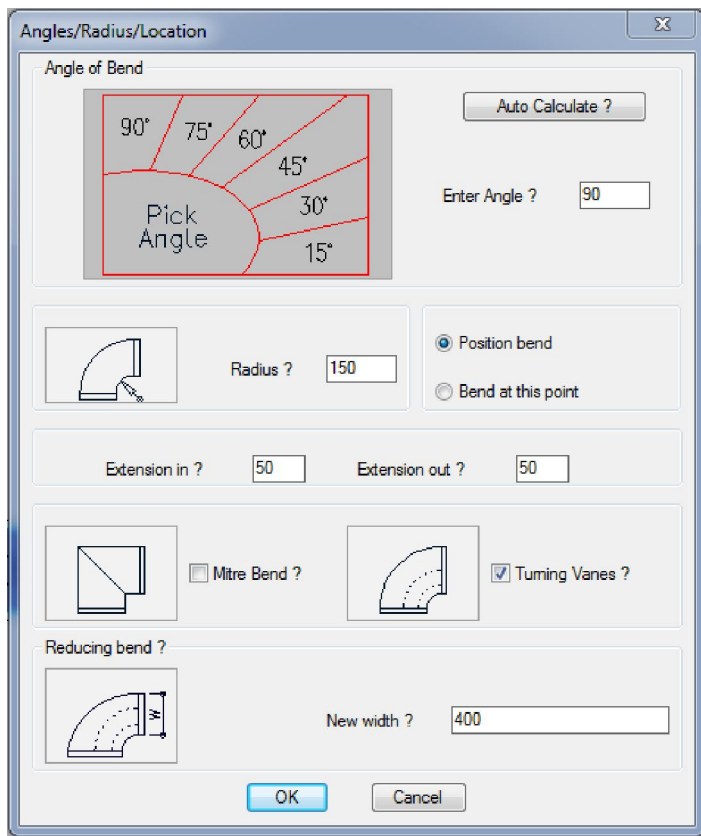

Dialog Type E

To enter the angle of the bend the user has three options

- a) By clicking on the angle shown in the image or
- b) By entering the required angle in the box provided or
- c) Clicking on the Auto Calculate button where the user is requested to pick 2 points for the computer to calculate the desired angle.

The radius of the bend is defaulted by the software to the normally used distance or the user can enter a desired distance in the box provided.

To position the bend the user can drag the drawn bend into the required location (or enter a distance). There is also the option to just draw the bend at the point where the command was started.

The bend extension in and out is the straight section before the start and after the finish of the radius. The standard setting is the default but can be altered by the user to suite is requirements.

There is an option to draw a mitre bend by ticking on the box, if not ticked the software will draw the bend with the required radius set by the distance entered earlier.

Turning vanes are defaulted to on if not required just un-tick the tick box.

To have a reducing bend enter the new width of the bend required. If the size the user enters is either too big or small they will be shown a warning as in the dialog below and then must re-enter the correct width.

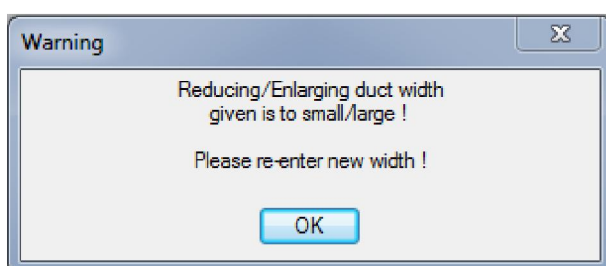

When all the values and items are what the user requires the OK button must be pressed. The bend will then be drawn with colours and layers as setup in the configuration section (Explained later in this user manual). If the bend has an angle different to 90 degrees the user will be prompted to position the text indicating that angle.



- Duct double bend

As per the duct section the user will be prompted with the same question:-

Select existing object or Enter to start !!!

Follow the same steps in Dialog Type A and Type B and select the centre line start point. Or click on an existing HVACPAC entity and the software will use that entities settings such as Type, size, direction, etc .

The following dialog will appear requesting user input for the sizes of bends to be drawn

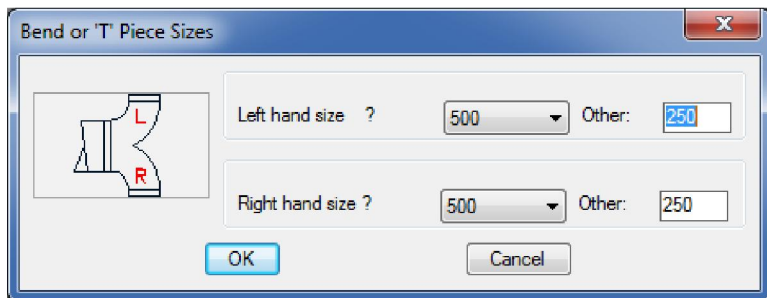

The user must supply the required bend widths (Note: if a different depth is required a transformation must be drawn first to achieve the desired depth) Press OK to continue.

The double bends will be drawn at the same point indicated or will be attached to an existing duct. The user can then continue with the duct runs or choose another option from the ribbon.



- Duct trouser piece

As per the duct section the user will be prompted with the same question:-

Select existing object or Enter to start !!!

Follow the same steps in Dialog Type A and Type B and select the centre line start point. Or click on an existing HVACPAC entity and the software will use that entities settings such as Type, size, direction, etc .

The following dialog will appear requesting user input for the sizes of bend and duct straight to be drawn

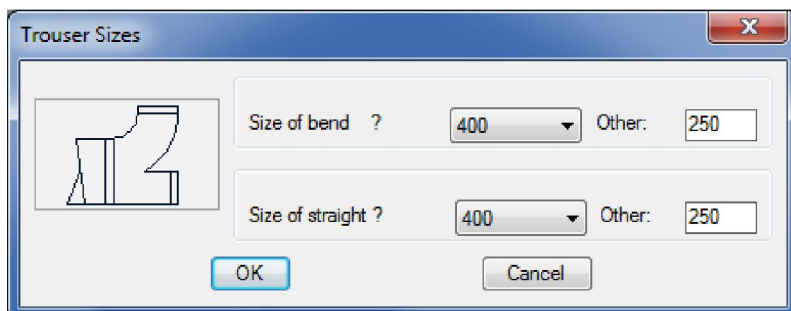

The user must supply the required bend and straight widths (Note: if a different depth is required a transformation must be drawn first to achieve the desired depth) Press OK to continue.

The trouser piece will be drawn at the same point indicated or will be attached to an existing duct. The user can then continue with the duct straight run or choose another option from the ribbon.



- Duct offset piece

As per the duct section the user will be prompted with the same question:-

Select existing object or Enter to start !!!

Follow the same steps in Dialog Type A and Type B and select the centre line start point. Or click on an existing HVACPAC entity and the software will use that entities settings such as Type, size, direction, etc .

The following prompt will appear requesting the user to pick the desired offset of the duct to be drawn

Indicate point (No greater than 15') to offset to :

Note that the offset given must be less than 15 degrees or the software will not draw the offset. Once satisfied with the angle the offset will be drawn and the user prompted to position the text indicating the angle of the offset. The user can then continue with the duct straight run or choose another option from the ribbon.



- Duct dropping sections

When selecting this option off the ribbon the following dialog will be displayed

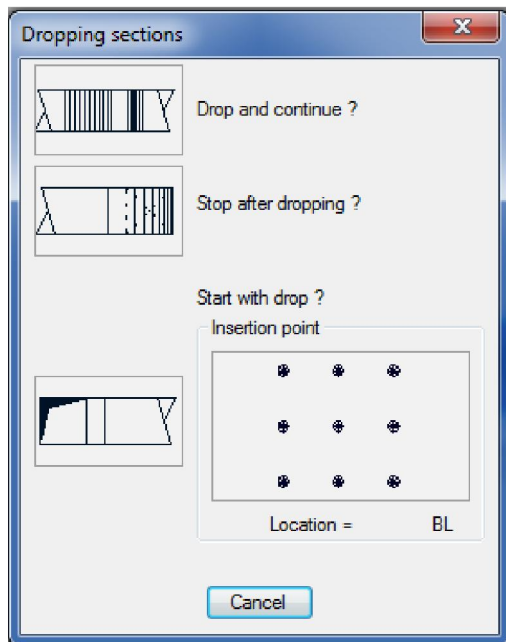

The user will have the option to (a) drop and continue the existing duct run or (b) stop after dropping down or (c) to start with a dropping section.

a) When selecting the drop and continue option the user will be prompted with the same question:-

Select existing object or Enter to start !!!

Follow the same steps in Dialog Type A and Type B and select the centre line start point.

Or click on an existing HVACPAC entity and the software will use that entities settings such as Type, size, direction, etc .

Once initiated the display screen will change to a side view and Dialog Type E will appear to ask the angle of the bend. (Note: No other options on the dialog will work with the dropping duct sections)

Once the angle has been entered using any of the input methods available the user will be able to drag the displayed bend into the required position. A depth indicator is shown on the right of the screen to indicate how far the duct has dropped. Note when this depth is reached and is to the users' satisfaction the pick button must be used and not the amount entered at the command prompt to get the correct depth indicated on the plan view.

Once picked the display screen will return to the plan view and the duct drop depth will be textually indicated on the layout. The user can then continue with the duct straight run or choose another option from the ribbon.

b) When selecting the Stop after dropping option the user will be prompted with the same question:-

Select existing object or Enter to start !!!

Follow the same steps in Dialog Type A and Type B and select the centre line start point. Or click on an existing HVACPAC entity and the software will use that entities settings such as Type, size, direction, etc .

Once initiated the following dialog box will appear and ask the user to enter radius of the dropping bend

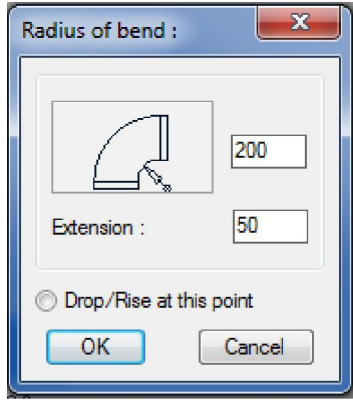

Dialog Type F

Here the user can indicate the bend radius, extension into the bend and to drop at this point or to drag the dropping section to a point on the screen.

c) Before selecting the start with drop option the user must indicate the insert point required for the drop and once selected he/she will be prompted with the same question:-

Select existing object or Enter to start !!!

Follow the same steps in Dialog Type A and Type B and select the centre line start point. Once initiated Dialog box Type F will appear and ask the user to enter radius of the dropping bend, extension out of the bend. Once entered and OK pressed the user will be prompted to

Position in required location !!!

When positioned the dropping section will be drawn in the selected insert and picked point.

Tip: If the user wants to move or copy the dropping section a node has been placed at the centre of the dropping section and can be used as an osnap when carrying out the command.



- Duct rising sections

When selecting this option off the ribbon the following dialog will be displayed

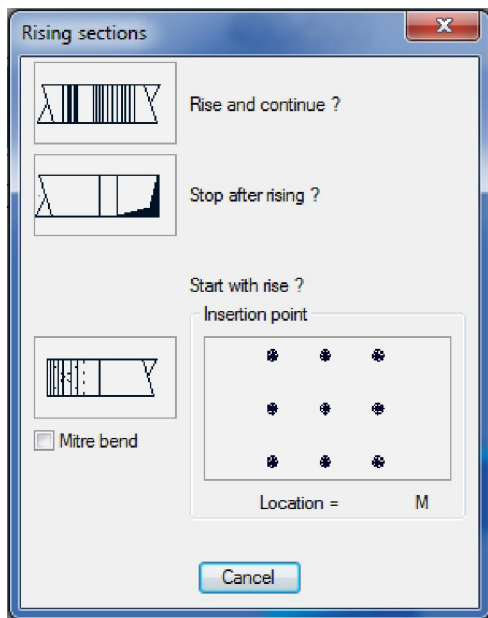

Note that the rising duct sections are just a reverse of the dropping duct sections as described above.



- Duct risers

When selecting this option off the ribbon the following riser dialog will appear

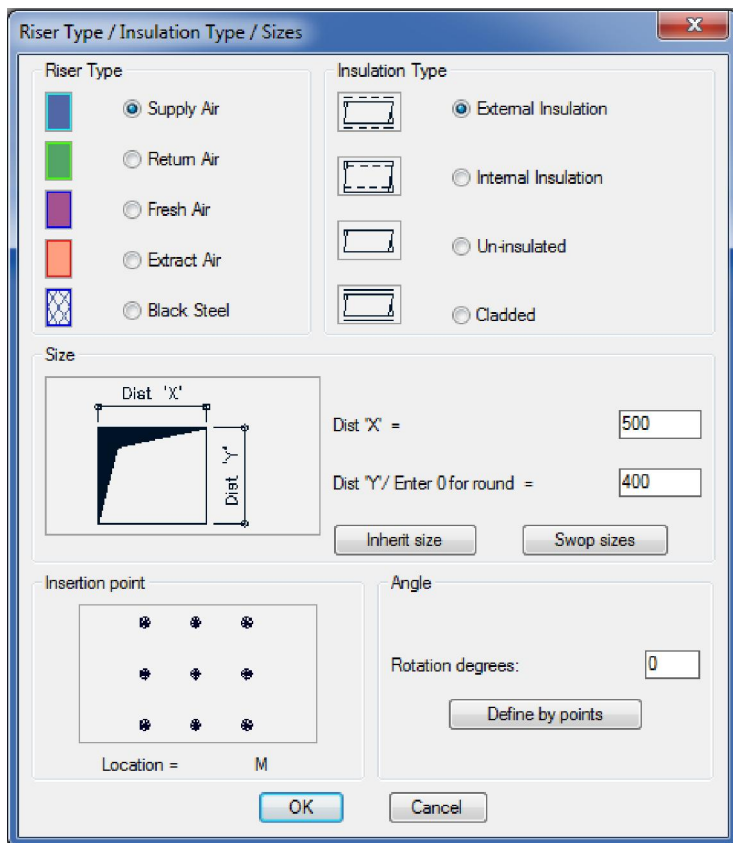

Here the user can select the type of duct, type of insulation, duct size (Using the same methods in Dialog Type B), the required insert location and the required angle of the riser (Also has the option to define the angle by picking 2 points)

Once all the fields are entered the user clicks on the OK button and can position the riser in the required location.

Tip: If the user wants to move or copy the riser a node has been placed at the centre of the riser and can be used as an osnap when carrying out the command.

Tip: A shoe can be placed onto the side of the riser duct shown in the plan view.



- Duct plenums

When selecting this option off the ribbon the following riser dialog will appear

Plenum Type / Insulation Type / Sizes

Plenum Type

- Supply Air
- Return Air
- Fresh Air
- Extract Air
- Black Steel

Insulation Type

- External Insulation
- Internal Insulation
- Un-insulated
- Cladded

Size

Dist 'X' = 500

Dist 'Y' = 500

Dist 'Z' = 500

Inherit size Swop sizes

Insertion point

Location = BL

Angle

Rotation degrees: 0

Define by points

OK Cancel

Here the user can select the type of duct, type of insulation, duct size (Using the same methods in Dialog Type B), the required insert location and the required angle of the plenum (Also has the option to define the angle by picking 2 points)

Once all the fields are entered the user clicks on the OK button and can position the plenum in the required location.

Tip: If the user wants to move or copy the plenum a node has been placed at the centre of the riser and can be used as an osnap when carrying out the command.

Tip: A shoe can be placed onto the side of the plenum duct shown in the plan view.



- Duct end connections

When selecting this option off the ribbon the following end connection dialog will appear

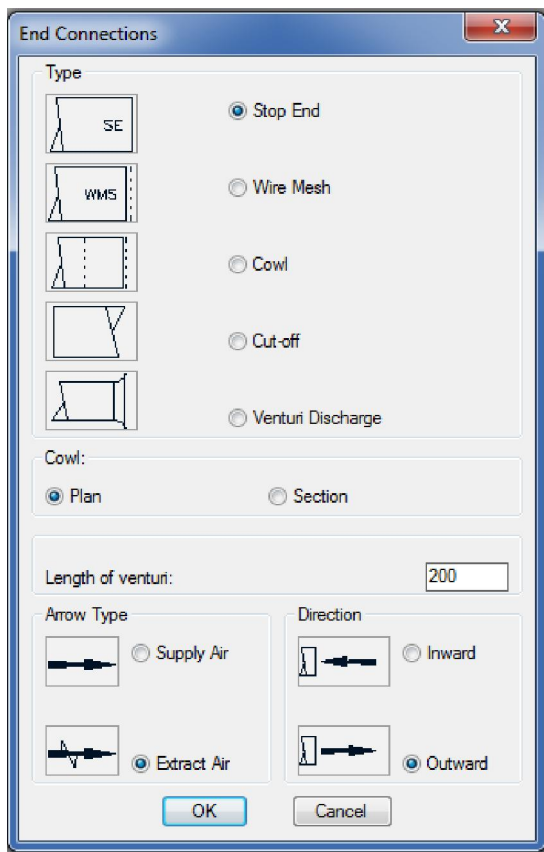

The user has five options to add end connections to a duct run

- The stop end adds a notation "SE" at the end of the duct to indicate that the duct end has terminated.
- The wire mesh adds an arrow as selected in the arrow type area and in the direction as indicated in the direction area. Once selected the user can then position the textual annotation "WMS" close to the termination
- The cowl is identical to the wire mesh but adds a cut-back duct section onto the end of the duct. In the cowl area the user can indicate that the cowl is in the plan or section view when the cowl is drawn.
- The cut-off shows a cut-off section as long as indicated by the user .
- Venturi discharge draws the venturi at the end of the duct and adds a wire mesh as per item b.

Spigots & Flexibles :



- Spigot and flexible connection

This command can only be used if there is an existing duct present in the editing session. Once selecting this option from the ribbon the following dialog box will be displayed

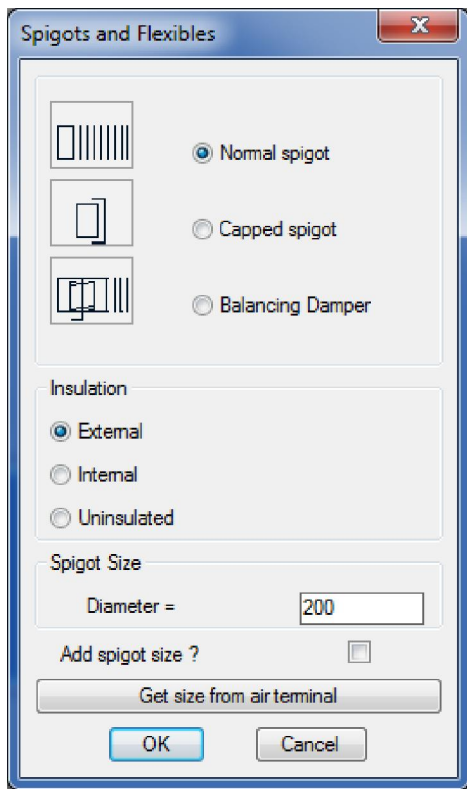

The user has three options for the type of spigot to be indicated on the duct run. All three are indicated as per the insulation and sizes selected in the dialog. The user selects the type of insulation and enters the size of the required spigot. The size can also be inherited from an air terminal (Described later in this user manual). There is also an option to add a size to the spigot when it is inserted.

On clicking the OK button the following prompt will appear and ask the user on which duct to attach to.

Indicate duct to attach to:

Here the user must click on the existing duct. Note it is important to click on the existing duct on the side that you want the spigot to be placed. Once indicated the following prompt is displayed

Position spigot on duct in required location

The user can now drag or enter a distance to position the new spigot onto the face of the existing duct.

If the user selected the :-

- a) Normal spigot option then the user can continue with the flexible duct run by indicating pick points to the required location.
- b) Capped spigot option where the spigot is displayed with a capped off section
- c) Balancing damper option where a damper will be drawn onto the spigot and the user prompted to **Indicate which side to place damper lever** Once selected the user can position the textual identification "BD" next to the damper. If the user presses either the return or enter button he can continue with the duct run and add a flexible by using the method below.



- Extended Spigots

This command also can only be used if there is an existing duct present in the editing session. Once selecting this option from the ribbon the following dialog box will be displayed

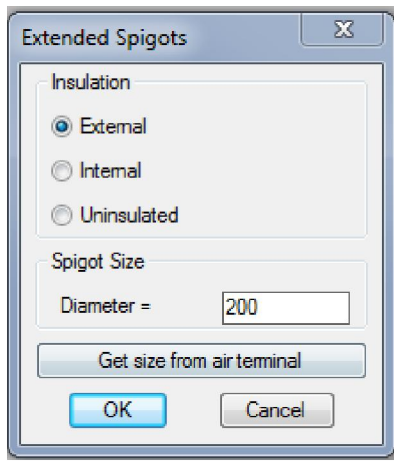

The user selects the type of insulation and enters the size of the required spigot. The size can also be inherited from an air terminal (Described later in this user manual).

On clicking the OK button the following prompt will appear and ask the user on which duct to attach to.

Indicate duct to attach to:

Here the user must click on the existing duct. Note it is important to click on the existing duct on the side that you want the spigot to be placed. Once indicated the following prompt is displayed

Position spigot on duct in required location

The user can now drag or enter a distance to position the new spigot onto the face of the existing duct. Once the spigot is positioned the user can continue with the duct run and then continue with the flexible duct run by indicating pick points to the required location.



- Flexible duct runs

On selecting this option the user will be prompted with the question:-

Select existing object or Enter to start !!!

Click on an existing HVACPAC entity and the software will use that entities settings such as Type, size, direction, etc . or press enter and the following dialog will appear requesting user input for the flexible size and angle

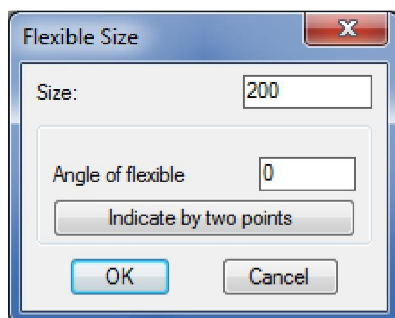

When clicking the OK button the user can draw up the flexible by indicating pick points to the required location.



- Flexible canvas joints

As per the duct section the user will be prompted with the same question:-

Select existing object or Enter to start !!!

Follow the same steps in Dialog Type A and Type B and select the centre line start point. Or click on an existing HVACPAC entity and the software will use that entities settings such as Type, size, direction, etc .

The following dialog will appear requesting the user to input the length of the canvas flexible.

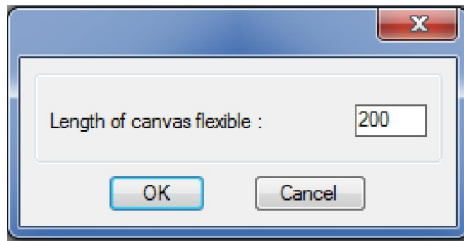

Dialog Type G

Click OK and the canvas flexible will be drawn to the length entered by the user.

Equipment :



When selecting this option off the ribbon the following fan dialog will appear

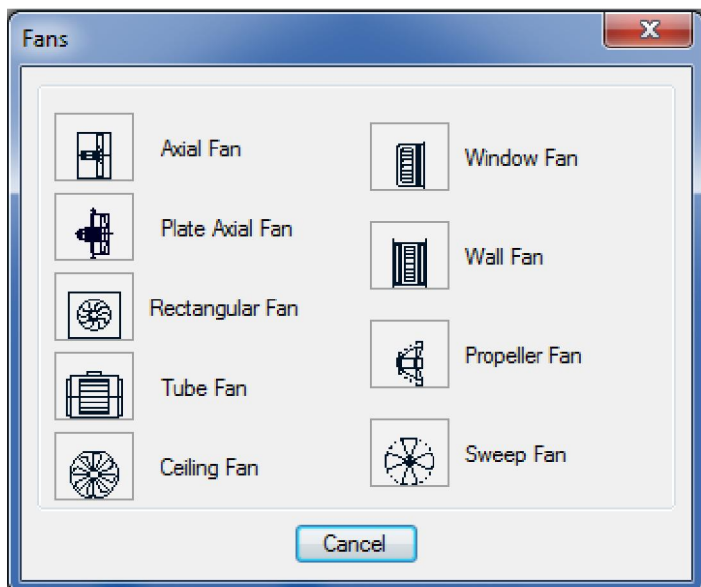

As per the duct section the user will be prompted with the same question:-

Select existing object or Enter to start !!!

Follow the same steps in Dialog Type A and Type B and select the centre line start point. Or click on an existing HVACPAC entity and the software will use that entities settings such as Type, size, direction, etc .

The following dialog will appear requesting the user to input the fan data.

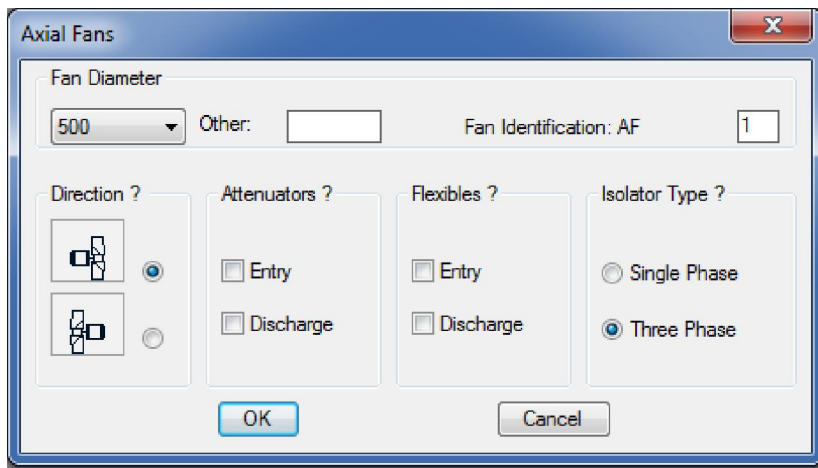

Here the user can enter the fan diameter, fan identification, the direction in which to display the fan, whether the fan has attenuators on either side and what type, whether the fan needs canvas flexible connections on either side and what type of power supply the fan will use.

If the flexible connections are ticked dialog box type G will be presented to the user to enter the length of the canvas flexible once the OK button is clicked the flexible canvas will be drawn.

Likewise if the attenuators are ticked the dialog box below will be displayed

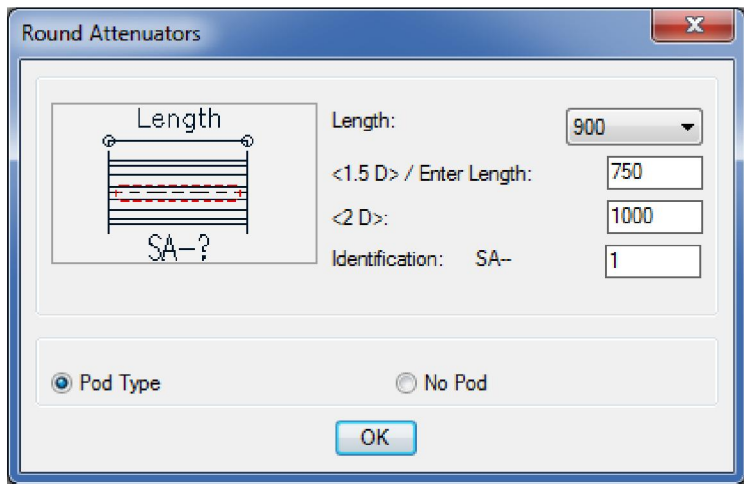

Dialog Type H

Here the user can enter the length, type and identification and click on the OK button. The attenuator will be drawn and the user will then be prompted to place the identification next to the attenuator.

Now the fan will be drawn and the user will once again be prompted to place the identification next to the fan followed by the placement of the electrical isolator.

If the user has ticked the discharge attenuator and flexible then the dialogs G and H will be displayed and the same procedures will be followed.



- Plate Axial Fan

The following dialog will be displayed after this selection is made

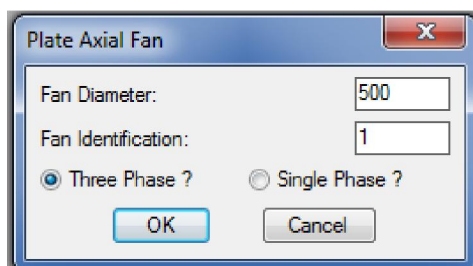

Here the user can enter the fan diameter, identification and type of power supply the fan will use.

When OK is clicked the fan will be drawn and will wait for the user to indicate the desired location and rotation once positioned the user will be prompted to place the identification next to the fan followed by the placement of the electrical isolator.



- Rectangular Fan

As per the duct section the user will be prompted with the same question:-

Select existing object or Enter to start !!!

Follow the same steps in Dialog Type A and Type B and select the centre line start point. Or click on an existing HVACPAC entity and the software will use that entities settings such as Type, size, direction, etc .

The following dialog will appear requesting the user to input the fan data.

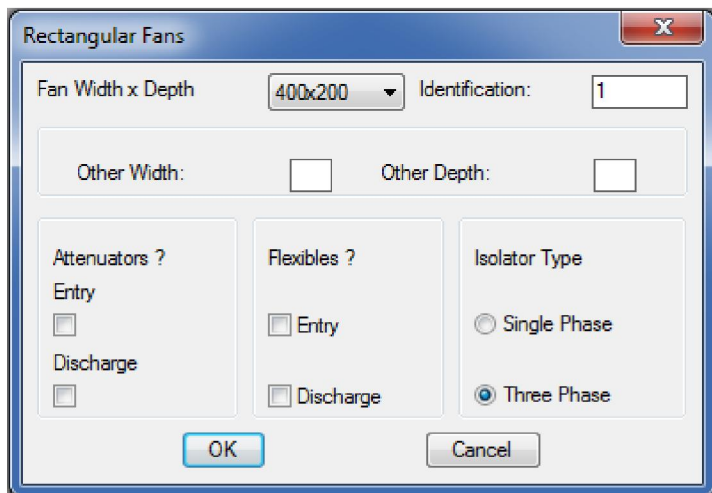

The 'Rectangular Fans' dialog box contains the following fields and options:

- Fan Width x Depth: 400x200 (dropdown)
- Identification: 1 (text input)
- Other Width: (checkbox)
- Other Depth: (checkbox)
- Attenuators ?
 - Entry: (checkbox)
 - Discharge: (checkbox)
- Flexibles ?
 - Entry: (checkbox)
 - Discharge: (checkbox)
- Isolator Type
 - Single Phase: (radio button)
 - Three Phase: (radio button, selected)
- Buttons: OK, Cancel

Here the user can enter the fan size, fan identification, whether the fan has attenuators on either side, whether the fan needs canvas flexible connections on either side and what type of power supply the fan will use.

If the flexible connections are ticked dialog box type G will be presented to the user to enter the length of the canvas flexible once the OK button is clicked the flexible canvas will be drawn.

Likewise if the attenuators are ticked the dialog box below will be displayed

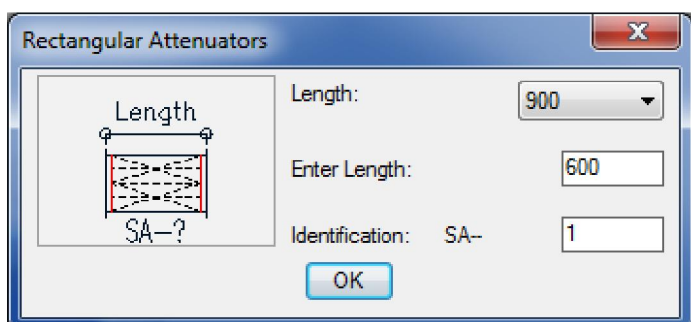

The 'Rectangular Attenuators' dialog box contains the following fields and options:

- Length: 900 (dropdown)
- Enter Length: 600 (text input)
- Identification: SA- 1 (text input)
- Diagram: A schematic showing a rectangular attenuator with a dashed line and the label 'SA-?' below it.
- Button: OK

Dialog Type I

Here the user can enter the length and identification and click on the OK button. The attenuator will be drawn and the user will then be prompted to place the identification next to the attenuator.

Now the fan will be drawn and the user will once again be prompted to place the identification next to the fan followed by the placement of the electrical isolator.

If the user has ticked the discharge attenuator and flexible then the dialogs G and I will be displayed and the same procedures will be followed.



- Tube Fan

As per the duct section the user will be prompted with the same question:-

Select existing object or Enter to start !!!

Follow the same steps in Dialog Type A and Type B and select the centre line start point. Or click on an existing HVACPAC entity and the software will use that entities settings such as Type, size, direction, etc .

The following dialog will appear requesting the user to input the fan data.

The 'Tube Fans' dialog box includes the following fields and options:

- Fan Diameter: 400 (dropdown menu)
- Other: (empty text box)
- Fan Type: (two icons representing different fan types)
- Identification: 1 (text box)
- Attenuators ?
 - Entry:
 - Discharge:
- Flexibles ?
 - Entry:
 - Discharge:
- Isolator Type
 - Single Phase:
 - Three Phase:

Buttons: OK, Cancel

Here the user can enter the fan size, fan type, fan identification, whether the fan has attenuators on either side, whether the fan needs canvas flexible connections on either side and what type of power supply the fan will use.

If the flexible connections are ticked dialog box type G will be presented to the user to enter the length of the canvas flexible once the OK button is clicked the flexible canvas will be drawn.

Likewise if the attenuators are ticked the dialog box Type H will be displayed

Here the user can enter the length, type and identification and click on the OK button. The attenuator will be drawn and the user will then be prompted to place the identification next to the attenuator.

Now the fan will be drawn and the user will once again be prompted to place the identification next to the fan followed by the placement of the electrical isolator.

If the user has ticked the discharge attenuator and flexible then the dialogs G and H will be displayed and the same procedures will be followed.



- Ceiling Fan

The following dialog will be displayed after this selection is made

The 'Ceiling Fan' dialog box includes the following fields and options:

- Size: 250 (dropdown menu)
- Other: (empty text box)
- Identification: 1 (text box)

Buttons: OK

Here the user can enter the fan diameter and identification. Note all ceiling fans will be single phase so the question regarding the power supply is not asked for from the user.

When OK is clicked the fan will be drawn and will wait for the user to indicate the desired location once positioned the user will be prompted to place the identification next to the fan followed by the placement of the electrical isolator.



- Window Fan

The following dialog will be displayed after this selection is made

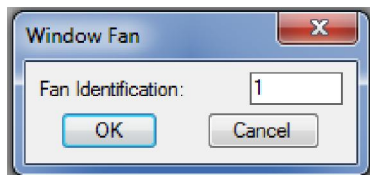

The user must enter the fan identification. Note all window fans will be single phase so the question regarding the power supply is not asked for from the user.

When OK is clicked the fan will be drawn and will wait for the user to indicate the desired location and rotation once positioned the user will be prompted to place the identification next to the fan followed by the placement of the electrical isolator.



- Wall Fan

The following dialog will be displayed after this selection is made

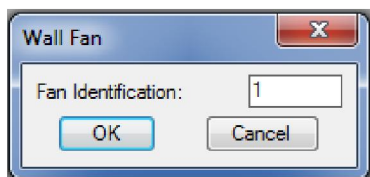

The user must enter the fan identification. Note all wall fans will be single phase so the question regarding the power supply is not asked for from the user. Once OK is clicked the dialog below will be displayed for the user to enter the wall width and fan angle

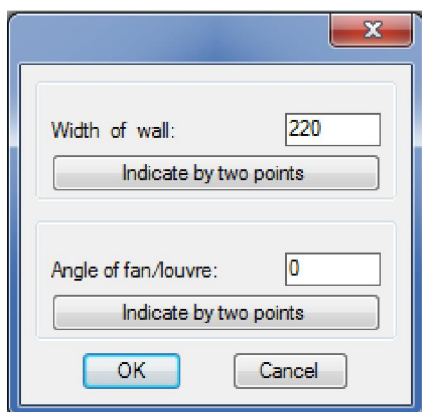

When OK is clicked the fan will be drawn and will wait for the user to indicate the desired location once positioned the user will be prompted to place the identification next to the fan followed by the placement of the electrical isolator.



- Propeller Fan

The following dialog will be displayed after this selection is made

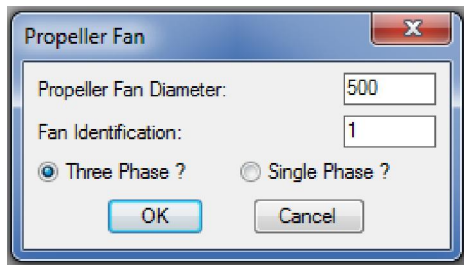

Here the user can enter the fan diameter, identification and type of power supply the fan will use.

When OK is clicked the fan will be drawn and will wait for the user to indicate the desired location and rotation once positioned the user will be prompted to place the identification next to the fan followed by the placement of the electrical isolator.



- Sweep Fan

The following dialog will be displayed after this selection is made



The user must enter the fan identification. Note all sweep fans will be single phase so the question regarding the power supply is not asked for from the user.

When OK is clicked the fan will be drawn and will wait for the user to indicate the desired location once positioned the user will be prompted to place the identification next to the fan followed by the placement of the controller and the control wiring.



- Sound attenuators

As per the duct section the user will be prompted with the same question:-

Select existing object or Enter to start !!!

Follow the same steps in Dialog Type A and Type B and select the centre line start point. Or click on an existing HVACPAC entity and the software will use that entities settings such as Type, size, direction, etc .

Either dialog Type H or I will appear depending on the duct being rectangular or circular.

The procedure to produce the sound attenuator is the same as described above in the fan section.



- Filters

As per the duct section the user will be prompted with the same question:-

Select existing object or Enter to start !!!

Follow the same steps in Dialog Type A and Type B and select the centre line start point. Or click on an existing HVACPAC entity and the software will use that entities settings such as Type, size, direction, etc .

The following dialog will appear requesting the user to input the filter data.

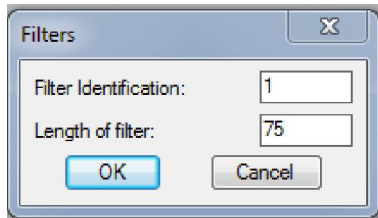

Here the user can enter the filter identification and length. When OK is clicked the filter will be drawn and the user will be prompted to place the identification next to the filter.



- Dampers

When selecting this option off the ribbon the following damper dialog will appear.

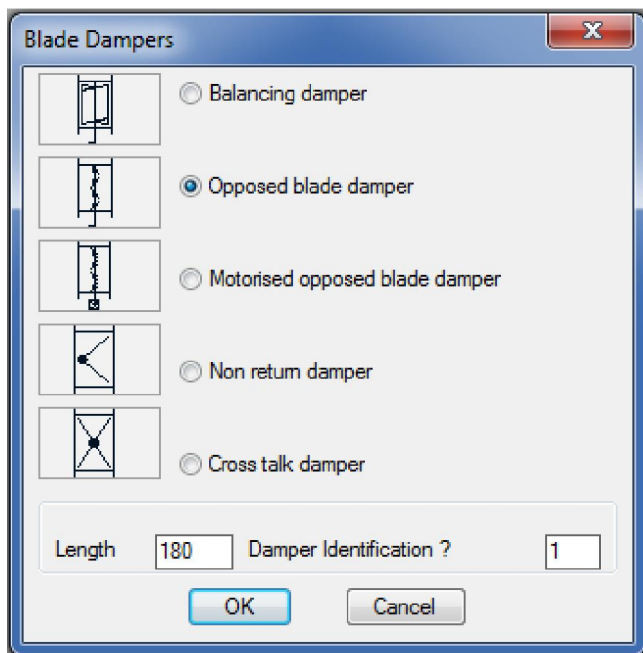

Here the damper type, length and identification can be entered.

For all dampers the start will be as per the duct section the user will be prompted with the same question:-

Select existing object or Enter to start !!!

Follow the same steps in Dialog Type A and Type B and select the centre line start point. Or click on an existing HVACPAC entity and the software will use that entities settings such as Type, size, direction, etc .



- Balancing Damper

On clicking OK the damper will be drawn and the user prompted to

Indicate which side to place damper lever

The user can then click on which side of the damper that he/she wants the lever to be positioned then he/she will be prompted to place the identification next to the damper.



- Opposed Blade Damper

On clicking OK the damper will be drawn and the user prompted to

Indicate which side to place damper lever

The user can then click on which side of the damper that he/she wants the lever to be positioned then he/she will be prompted to place the identification next to the damper.



- Motorised Opposed Blade Damper

On clicking OK the damper will be drawn and the user prompted to

Position damper motor in required location

The user can then click on which side of the damper that he/she wants the motor to be positioned then he/she will be prompted to place the identification next to the damper.

Tip: The damper motor can be repositioned or removed using the editing tool (Explained later in this user manual).



- Non Return Damper & - Crosstalk Damper

On clicking OK the damper will be drawn and the user prompted to

Position Identification text !



- Fire Dampers

When selecting this option off the ribbon the following fire damper dialog will appear.

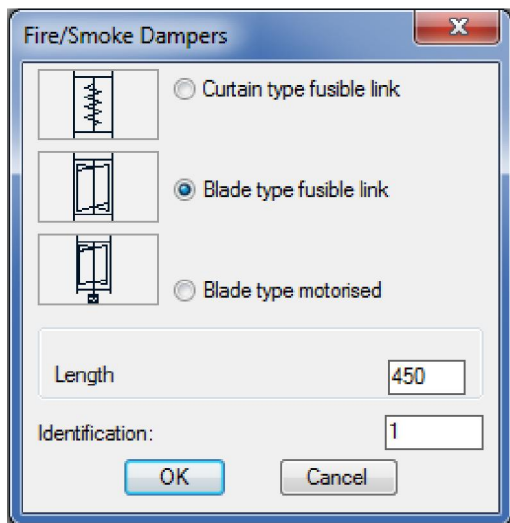

Here the fire damper type, length and identification can be entered.

For all fire dampers the start will be as per the duct section the user will be prompted with the same question:-

Select existing object or Enter to start !!!

Follow the same steps in Dialog Type A and Type B and select the centre line start point. Or click on an existing HVACPAC entity and the software will use that entities settings such as Type, size, direction, etc .

On clicking OK the fire damper chosen will be drawn and the user prompted to

Position Identification text !

If the Blade type motorised was chosen the user would have also been prompted to

Position damper motor in required location

Tip: The damper motor can be repositioned or removed using the editing tool (Explained later in this user manual).



- Duct Heaters

As per the duct section the user will be prompted with the same question:-

Select existing object or Enter to start !!!

Follow the same steps in Dialog Type A and Type B and select the centre line start point. Or click on an existing HVACPAC entity and the software will use that entities settings such as Type, size, direction, etc .

Then the following duct heater dialog will appear.

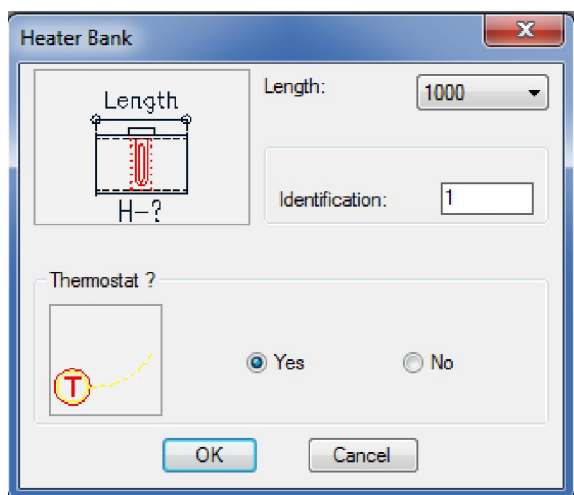

Here the user can enter the Length, Identification and if a thermostat must be used.

On clicking OK the outline of the duct heater will be drawn and the user prompted to

Indicate which side to position electrical controls

Here the user can click on which side of the heater he wants the heater control box once done the duct heater is drawn and the user is prompted to

Position identification text !

Once the identification is positioned and if the user selected to show a thermostat he will be prompted

Position thermostat

Once located he/she will be prompted to

Start position of control wiring: and

Middle position of control wiring:

And the control wiring will be drawn when the end point is indicated lastly the user will be prompted to

Position isolator



- AC Split Units

When selecting this option off the ribbon the following slit unit dialog will appear.

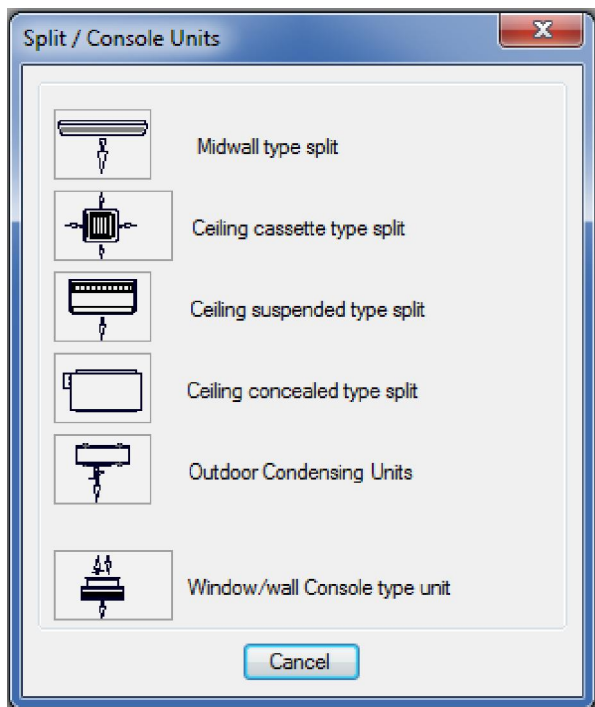

 - Split Midwall Units &
  - Ceiling Cassette Units &
  - Ceiling Suspended Units

When selecting either one of these option off the above split unit dialog a typical dialog as shown below will be displayed

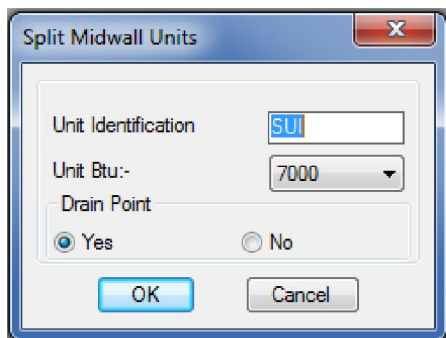

Here the user can enter the split unit identification, the capacity (In British Thermal Units) and whether to show a drain point next to the split unit.

When OK is clicked the split unit will be drawn and will wait for the user to indicate the desired rotation and location once positioned the user will be prompted to place the identification next to the unit followed by the placement of the drain if he/she made this selection.

 - Ceiling Concealed Units

When selecting this option off the above split unit dialog the concealed split unit dialog as shown below will be displayed

User Concealed Split AC Units

Unit Identification:

Unit Btu:-

Unit Casing:-
 Width: Depth:

Unit SA Spigot:-
 Width: Depth:



Unit RA Spigot:-
 Width: Depth:

Drain Point
 Yes No

Return Air Plenum
 Yes No

Plenum width:
 Plenum depth:

Uninsulated
 Externally insulated
 Internally insulated

 
 Left Right

Here the user can enter the split unit identification, the capacity (In British Thermal Units), Unit casing plus spigot sizes, whether to show a drain point next to the split unit and a return air plenum attached to the return spigot. There is also an option to determine if the unit pipe connections are on the left or the right.

When OK is clicked the split unit will be drawn (plus the return air plenum if selected) and will wait for the user to indicate the desired rotation and location once positioned the user will be prompted to place the identification next to the unit followed by the placement of the drain if he/she made this selection.

Tip: When the unit is located on the drawing the user can pick on the transformation from the ribbon and when prompted **Select existing object or Enter to start !!!** he can click on the Split unit and the transformation will use the unit spigot size and rotation to continue



- Outdoor Condensing Units

When selecting this option off the above split unit dialog the condensing unit dialog as shown below will be displayed

Outdoor Condensing Units

Unit Identification: SUO

Unit Btu:-: 7000

Mounting type:

Wall mounted Slab mounted

Isolator:

Three Phase ? Single Phase ?

OK Cancel

Here the user can enter the condensing unit identification, the capacity (In British Thermal Units), if the unit is wall or slab mounted and whether the electrical isolator is single or three phase

When OK is clicked the condensing unit will be drawn and will wait for the user to indicate the desired rotation and location once positioned the user will be prompted to place the identification next to the unit followed by the placement of the electrical isolator.



- Outdoor Condensing Units

When selecting this option off the above split unit dialog the console type unit dialog as shown below will be displayed

Console Type Units

Unit Identification: CU

Unit Btu:-: 5000

Width of wall: 220

Indicate by two points

OK Cancel

Here the user can enter the console unit identification, the capacity (In British Thermal Units) and the wall thickness (Either by entering in the distance in the box provided or by indicating 2 points off the drawing)

When OK is clicked the console unit will be drawn and will wait for the user to indicate the desired rotation and location once positioned the user will be prompted to place the identification next to the unit followed by the placement of the single phase electrical isolator.



- AC Fan Coil Units

When selecting this option off the HVACPAC ribbon the fan coil unit dialog as shown below will be displayed

Here the user can enter the fan coil unit identification, the capacity (In kW), Unit casing plus spigot sizes, whether to show a drain point next to the split unit and a return air plenum attached to the return spigot. There is also an option to determine if the unit pipe connections are on the left or the right.

When OK is clicked the fan coil unit will be drawn (plus the return air plenum if selected) and will wait for the user to indicate the desired rotation and location once positioned the user will be prompted to place the identification next to the unit followed by the placement of the drain if he/she made this selection.

Tip: When the unit is located on the drawing the user can pick on the transformation from the ribbon and when prompted **Select existing object or Enter to start !!!** he can click on the Split unit and the transformation will use the unit spigot size and rotation to continue

Thermostats :



Thermostats

- Thermostats/Sensors

When selecting this option off the HVACPAC ribbon a thermostat will be drawn and the user prompted to

Position thermostat

Once located he/she will be prompted to

Start position of control wiring: and

Middle position of control wiring:

And the control wiring will be drawn when the end point is indicated

Tip: The start and end points of the control wiring are in osnap mode nearest for ease of connection to the thermostat and the equipment



- Unit controllers

When selecting this option off the HVACPAC ribbon a controller will be drawn and the user prompted to

Position controller

Once located he/she will be prompted to

Start position of control wiring: and

Middle position of control wiring:

And the control wiring will be drawn when the end point is indicated

Tip: The start and end points of the control wiring are in osnap mode nearest for ease of connection to the controller and the AC unit



- Control Wiring

When selecting this option off the HVACPAC ribbon the user will be prompted with

Start position of control wiring: and

Middle position of control wiring:

The control wiring will be drawn when the end point is indicated and the command will be repeated to draw following control wiring arcs until the user presses escape.

Tip: The start and end points of the control wiring are in osnap mode nearest for ease of connection to the AC equipment

Editing :



Tip: For editing text quickly the user can choose a shortcut key from the keyboard and in either the express tools alias editor or editing the acad.pgp file he can add the command MRTEXT. I use the 1 key and when pressing this I can edit any HVACPAC object that has text attached. You can also tap on dtext, text or dimensions to alter these.



- Edit Text

When selecting this option off the HVACPAC ribbon the user will be prompted with

Select an object with text to be changed :

If selecting a duct run c/w size and segment length as below



The following text edit dialog will be displayed

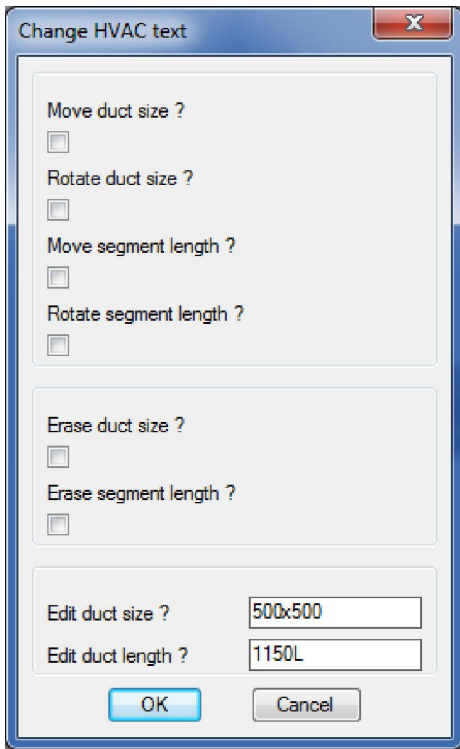

Now using the tick boxes the user can indicate if he wants to move or rotate (or do both) to either the duct size or the duct segment length. He/she can also erase the duct size or segment length.

The user can also change the duct size or change the duct segment length. **Please note that if these values are changed they will not be recorded in the bill of quantities, hence the bill will still calculate to the original values. So it is best to redraw the duct to the correct size and length for the bill to be accurate.**

When OK is clicked the user can then make the changes as picked in the dialog box.

If selecting a fitting c/w segment length and type as below



The following text edit dialog will be displayed

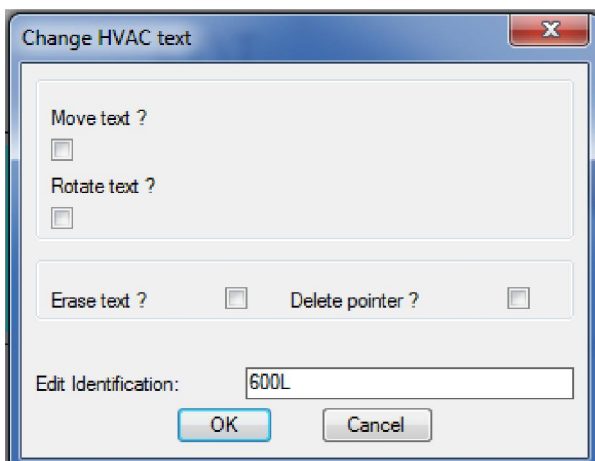

Dialog Type J

The editing is the same as shown above but the user can only work on one text entity at a time so this dialog will be shown twice to complete the commands on both text entities. The user can also delete any points that might have been created by HVACPAC

If selecting equipment with an identification as below



Dialog Type J will be displayed and the user will be able to move, rotate, erase or change the identification.



- Change Text Height, colour, rotation or erase text

When selecting this option off the HVACPAC ribbon the following dialog will be displayed

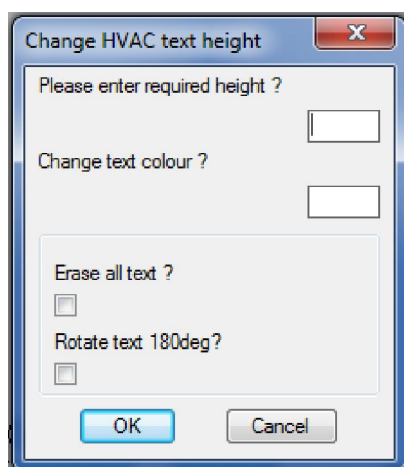

Dialog Type K

Here the user can enter the new text height or new colour, he/she can also choose to erase all the text or rotate the text through 180 degrees (This rotation is handy when using the HVACPAC mirror command explained later in this user manual)

When OK is clicked the user can then select all the HVACPAC objects he/she wants to alter.

Tip: If the user wants to plot all the ducting without the duct or segment lengths he/she can change the height to 1mm plot the drawing and then change back using the same command to the normal text height.



- Label HVAC Items

When selecting this option off the HVACPAC ribbon the user will be prompted with

Select existing entity :

Once selected the following dialog box will be displayed

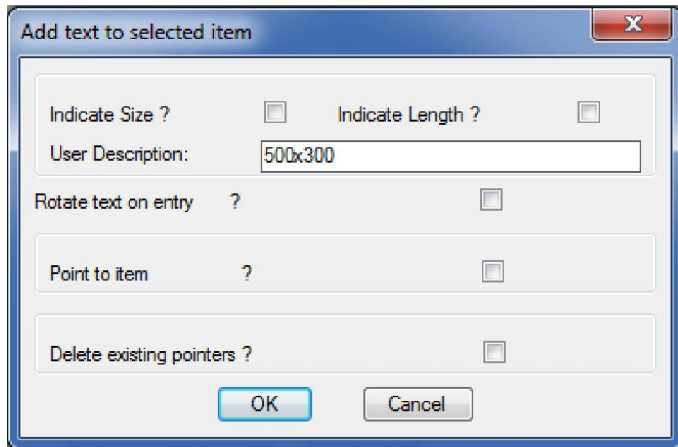

The user can tick the size and length for HVACPAC to display these on a duct if they had previously been erased. He/she can also add a user description (rotated if need be) to add his/her own words to an entity (Note: The size is commonly used so is defaulted into the box provided but this can easily be removed). The user can also add a pointer to an item or remove a previously added pointer.



- Edit Items

When selecting this option off the HVACPAC ribbon the following dialog will be displayed

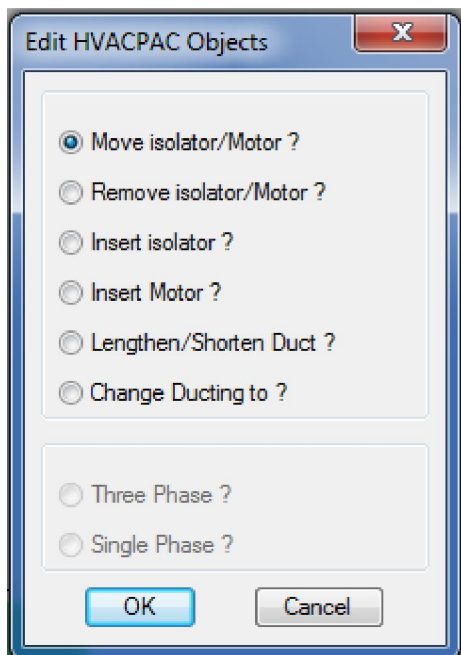

With this dialog the user can

- a) Move electrical isolators and motors
- b) Remove electrical isolators and motors
- c) Insert isolators
- d) Insert motors
- e) Lengthen or shorten existing duct lengths
- f) Change existing ducting

Note if item c) is selected the isolator types become available for user input to determine if they are single or three phase.

If item e) is selected the user will be prompted to

Select objects:

Once selected the user can drag the duct to make it shorter or longer.

If item f) is selected the following dialog will be displayed

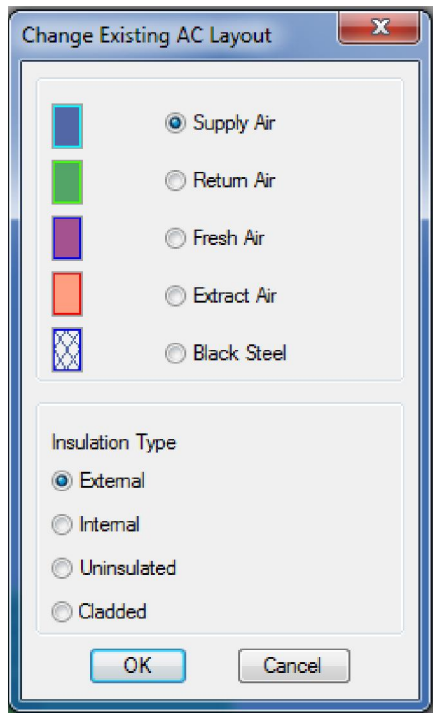

Here the user can select existing fittings to change their type or insulation



- Hidden lines

When selecting this option off the HVACPAC ribbon the following dialog will be displayed

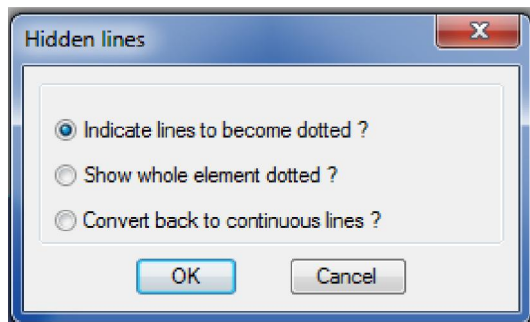

Here the user can select the hidden line option he/she wants.

If he chooses to indicate the lines he/she will be prompted to select the HVACPAC item that must be changed. A pair of scissors is shown at the cursor and the user must select the lines in the entity to cut. Once all the cut points are made the user must hit the enter button. Now he/she must select the lines in between the cut points that must be changed to hidden line type.

If the option to show the whole HVACPAC item dotted is chosen then the software will convert the objects line type to hidden and visa versa if the option to show the item line types continuous the software will change them back.

Note: This option will not work with 3D elements as they are made up of solids and cannot be cut or changed.



- Mirror objects

If the user has mirrored HVACPAC entities with text attached to them (using the AutoCAD mirror command) then he can reverse the text to make it legible by clicking on this icon.

The user is prompted with **Select objects** : when selected and the enter button pressed the text is corrected to be legible. If the text is upside down then the user can use dialog type K to rotate the text through 180 degrees.

Electrics :



Electrics

When selecting this option off the HVACPAC ribbon the following dialog will be displayed

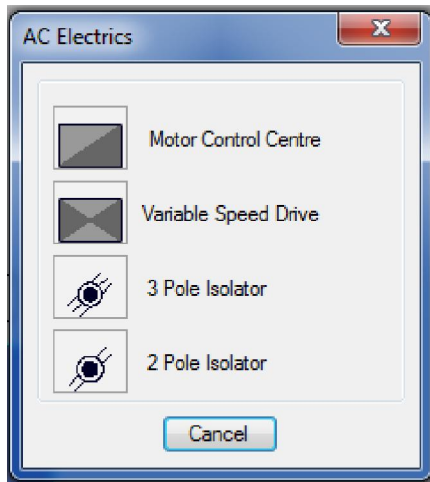

Here the user can make his/her selection from the four options provided

- a) Motor control centre where the following dialog will be displayed

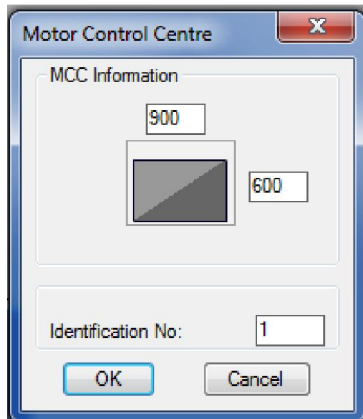

Here the user can give the MCC size and identification and once OK button is pressed he/she can rotate and then position the MCC thereafter positioning the identification in the desired position next to the MCC

- b) Variable speed drive where the following dialog will be displayed

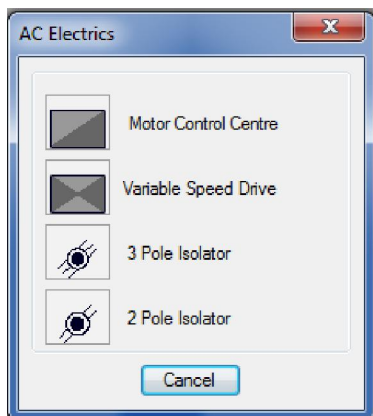

Here the user can give the VSD size and identification and once OK button is pressed he/she can rotate and then position the VSD thereafter positioning the identification in the desired position next to the VSD

- c) 3 pole isolator is drawn and the user prompted to indicate the location on the drawing
- d) 2 pole isolator is drawn and the user prompted to indicate the location on the drawing

Miscellaneous:

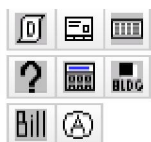

Miscellaneous



- Ducting configuration

Tip: This is an important part of HVACPAC to set up the application to perform to your requirements

When selecting this option off the HVACPAC ribbon the following dialog will be displayed

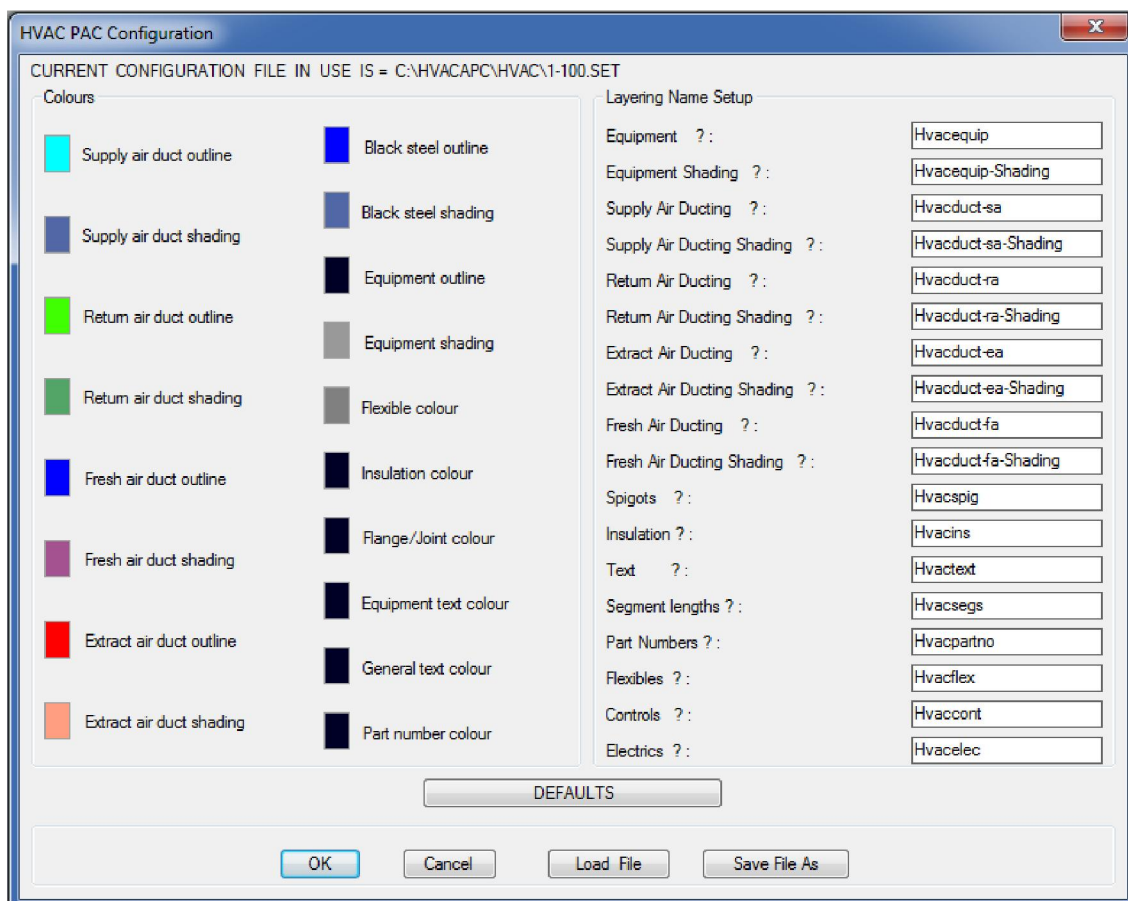

Here the user can configure all the colours and layer names for the different types of ducting and equipment used in HVACPAC. Once set the different types of configurations can be saved and loaded when the different settings are required.

If the DEFAULTS button is clicked then an additional dialog is displayed as shown below

DEFAULTS

Segment Lengths

Category 1 and 2 Duct Segment Lengths ? : 2450

Category 3 and 5 Duct Segment Lengths ? : 2450

Round Duct Segment Lengths ? : 3000

General

Maximum allowable flexible length ? : 2000

Bend extension default value ? : 50

Standard spigot length ? : 100

Duct size to be indicated

Clear air passage size ? Sheet metal size ?

Round ducting to be spiral wound

Yes No

Insulation

Thickness ? : 25

Display as ? : 35

Text

On ? Off ?

Equipment Text Height ? : 200

General Text Height ? : 155

Shading

On ? Off ?

Mezz flanges

On all ducting To SMACNA Standards

Draw 3D

Yes ? No ?

Directory Location of Microsoft Excel ? :

c:/program files/microsoft office/office 12/excel.exe

OK Cancel

In this section the user can change the lengths of duct segments to suit the duct manufactures requirements.

He/she can also control the maximum length that a flexible duct can be drawn. If the amount shown is exceeded HVACPAC will remove the flexible and display the following warning dialog for the user to correct the situation.

Warning

You have exceeded the maximum allowable flexible length !!!!!!!
Please use an extended spigot or increase the current spigot or duct length!

OK

Ducting bends have a straight section into and out of these bends this can be different between different duct manufacturers so this section enables the user to change the amount to suit the manufacturer being used.

Spigot lengths can also vary so an option here is to set the default length to be used.

Duct sizes can be changed to suit the clear air passage or the sheet metal size (This in particular is to suit when the duct in internally insulated)

Round ducting can either be displayed as spiral wound or straight sheet metal sections

Insulation thickness can be changed to suit the application and be correctly calculated in the bill. If the insulation thickness is too small say 19mm then the user can ask for it to be displayed on the drawing at a wider gap but to still be calculated to the correct thickness.

In the text section of this dialog the text can either be turned on or off and can be sized to suit the plot scale of the drawing.

The HVACPAC shading can either be turned on or off according to how the user wants his drawing to be displayed.

Mezz flanges on ducting is set to an American standard (SMACNA) and this standard does not include category types 1 & 2 of ductwork. Sometimes installations require that mezz flanges be used on all ducting and this can be done in this section where the flanges are drawn and calculated on all ducts.

HVACPAC can do limited 3D work and this can be controlled here if the user wants to do some modelled ductwork and equipment.

Finally HVACPAC needs to know where Microsoft Excel resides on your system so that the bill can automatically open up the spread sheet once calculated. This can be done by searching for excel.exe on your system and copying the path into the box provided.

Tip: 2 configuration files are provided with HVACPAC and they are 1-100.set for 1:100 scaled drawings and 1-50.set for 1:50 scaled drawings



- HVACPAC Enquiry

When selecting this option off the HVACPAC ribbon the user will be prompted to

Select existing entity :

And depending on the entity selected the following dialog will be displayed informing the user of the item, type, type of insulation, duct or equipment width/diameter, duct or equipment depth and the item length. If the item is a type of fitting then the category, sheet metal area and insulation area will be displayed.

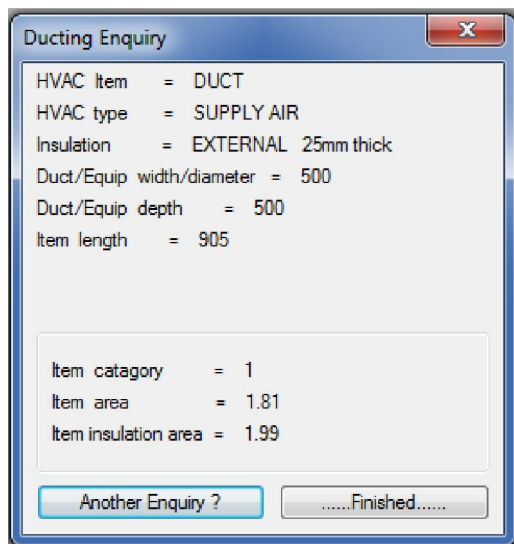

- Bill of quantities

When selecting this option off the HVACPAC ribbon the following dialog will be displayed

HVAC RATES

CURRENT RATE FILE IN USE IS = E:\HVAC\0.R

Insulation Rate =

Duct Category	1	2	3	4	5	6
STRAIGHT	<input type="text" value="0"/>	<input type="text" value="0"/>	<input type="text" value="0"/>	<input type="text" value="0"/>	<input type="text" value="0"/>	<input type="text" value="0"/>
SHOE	<input type="text" value="0"/>	<input type="text" value="0"/>	<input type="text" value="0"/>	<input type="text" value="0"/>	<input type="text" value="0"/>	<input type="text" value="0"/>
STOP END	<input type="text" value="0"/>	<input type="text" value="0"/>	<input type="text" value="0"/>	<input type="text" value="0"/>	<input type="text" value="0"/>	<input type="text" value="0"/>
TRANSFORMATION	<input type="text" value="0"/>	<input type="text" value="0"/>	<input type="text" value="0"/>	<input type="text" value="0"/>	<input type="text" value="0"/>	<input type="text" value="0"/>
SQUARE to ROUND	<input type="text" value="0"/>	<input type="text" value="0"/>	<input type="text" value="0"/>	<input type="text" value="0"/>	<input type="text" value="0"/>	<input type="text" value="0"/>
BEND	<input type="text" value="0"/>	<input type="text" value="0"/>	<input type="text" value="0"/>	<input type="text" value="0"/>	<input type="text" value="0"/>	<input type="text" value="0"/>
MITRE BEND	<input type="text" value="0"/>	<input type="text" value="0"/>	<input type="text" value="0"/>	<input type="text" value="0"/>	<input type="text" value="0"/>	<input type="text" value="0"/>
REDUCING BEND	<input type="text" value="0"/>	<input type="text" value="0"/>	<input type="text" value="0"/>	<input type="text" value="0"/>	<input type="text" value="0"/>	<input type="text" value="0"/>
REDUCING MITRE BEND	<input type="text" value="0"/>	<input type="text" value="0"/>	<input type="text" value="0"/>	<input type="text" value="0"/>	<input type="text" value="0"/>	<input type="text" value="0"/>
DOUBLE BEND	<input type="text" value="0"/>	<input type="text" value="0"/>	<input type="text" value="0"/>	<input type="text" value="0"/>	<input type="text" value="0"/>	<input type="text" value="0"/>
TROUSER PIECE	<input type="text" value="0"/>	<input type="text" value="0"/>	<input type="text" value="0"/>	<input type="text" value="0"/>	<input type="text" value="0"/>	<input type="text" value="0"/>
OFFSET	<input type="text" value="0"/>	<input type="text" value="0"/>	<input type="text" value="0"/>	<input type="text" value="0"/>	<input type="text" value="0"/>	<input type="text" value="0"/>
COWL	<input type="text" value="0"/>	<input type="text" value="0"/>	<input type="text" value="0"/>	<input type="text" value="0"/>	<input type="text" value="0"/>	<input type="text" value="0"/>
SPIGOT	<input type="text" value="0"/>	<input type="text" value="0"/>	<input type="text" value="0"/>	<input type="text" value="0"/>	<input type="text" value="0"/>	<input type="text" value="0"/>
PLENUM	<input type="text" value="0"/>	<input type="text" value="0"/>	<input type="text" value="0"/>	<input type="text" value="0"/>	<input type="text" value="0"/>	<input type="text" value="0"/>

OK Cancel Load File Save File As

Here the user enters the monetary value of the item and category to be billed. Rate files can be saved away and recalled to suit different values.

Once entered the user will be prompted to select the entities he wants billed. Once selected AutoCAD will open up Microsoft excel and the bill of the separate entities will be displayed on the spread sheet.

Tip: Make sure that the HVACPAC configuration file points correctly to where excel is on your workstation and also make sure that you click on Enable content when excel displays that message



- Equipment Tables

When selecting this option off the HVACPAC ribbon the user will be prompted to

Select objects:

and once he/she have selected the required objects the following prompt will be displayed

Indicate top left point of Schedules

Tables of equipment identifications, type and quantities will be placed on the drawing at the point indicated by the user.

Tip: Don't worry if fittings or other AutoCAD objects are in the selection window HVACPAC will filter them out of the selection



- HVAC Calculator

This handy little dialog below will be displayed for a quick calculation of free areas and sizes based on air volume and velocity.

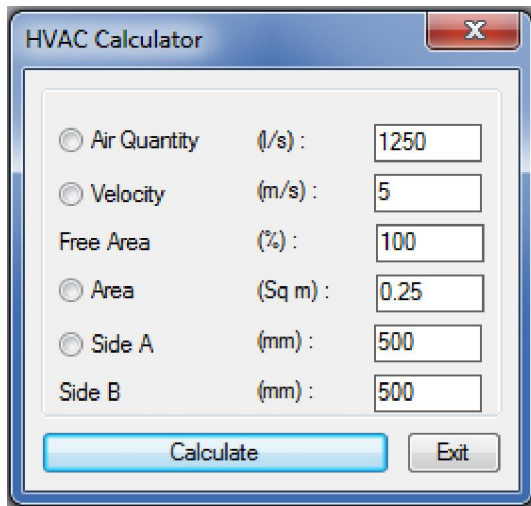

- Ducting Part Numbers

When selecting this option off the HVACPAC ribbon the following dialog will be displayed

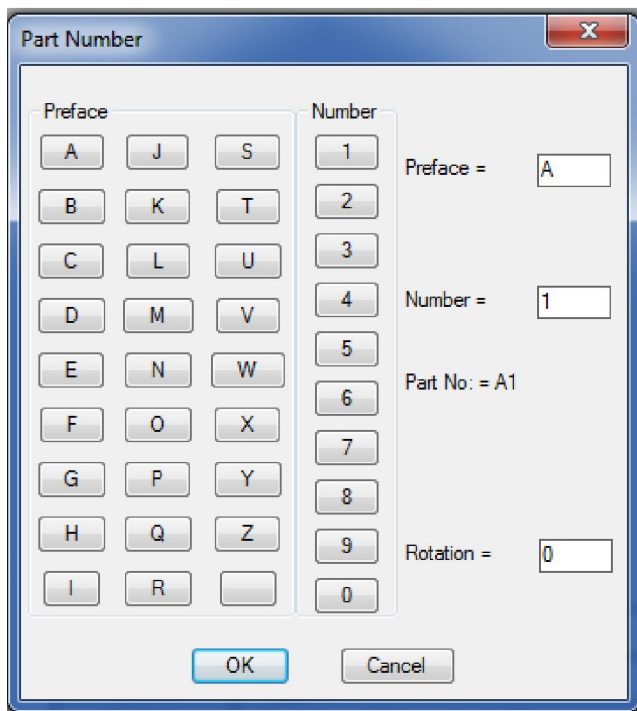

The user can enter a Preface for a certain duct run and a part number. On clicking OK he/she can position the label and the next label will be incremented by 1 and wait for placement. This will continue until the user presses the escape button.



- Room ID

Once this utility is selected the user can pick on architect room names and HVACPAC will place the name in a frame and position on the drawing where the user indicates.



- Building Cleaner

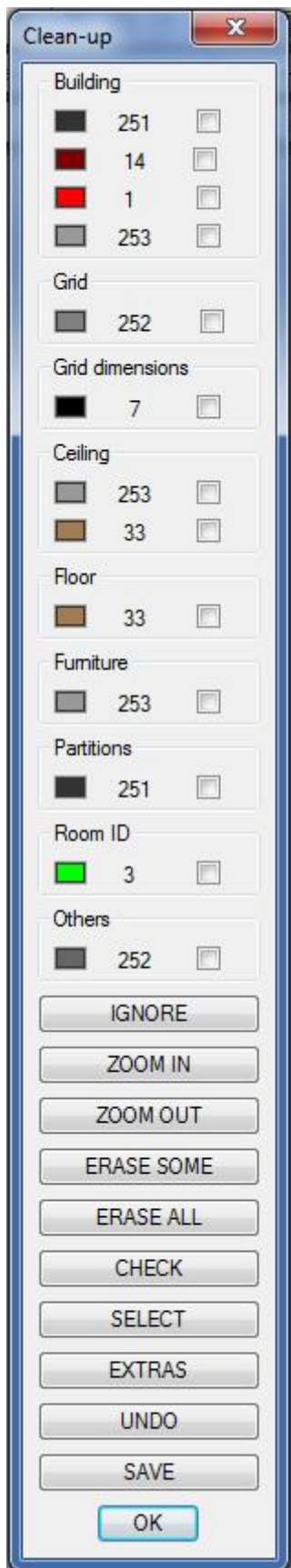

This utility is used for cleaning out Architectural buildings and placing them in the colours and the layers that the user chooses. There are other buttons that assist him/her to achieve a clean background to work on.

Piping :-

Connections :-



- Straight pipe sections

When the user selects this icon from the ribbon he/she will be prompted with the following question :-

Select existing object or Enter to start !!!

If there is an existing pipe fitting previously drawn by HVACPAC the user can click onto the object and the software will automatically continue with the selected objects properties, size and direction.

If the user presses Enter then the software will prompt them for the following information:-

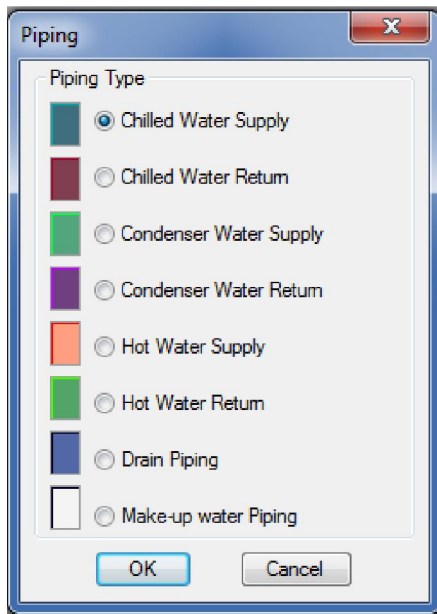

Dialog Type L

Here the user can choose the type of pipe run he wants to add to his drawing. Once selected the choices remain as the default for the rest of the editing session.

Once selected and the OK button pressed the size, angle and joint type dialog appears :-

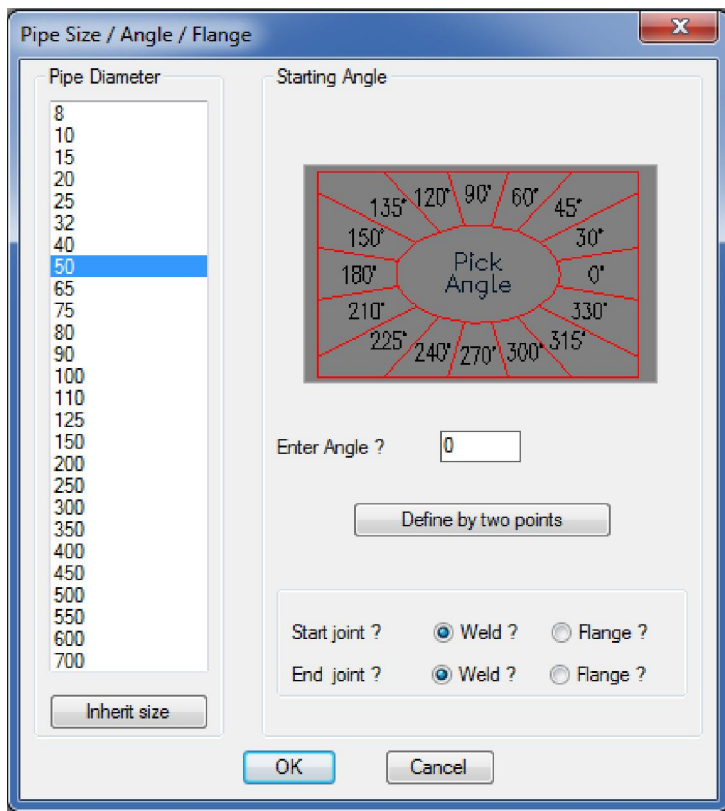

Dialog Type M

The user enters the pipe fitting size by selecting from the list provided in the dialog. If an existing HVACPAC object is present in the drawing and the user wants to use its size he/she can simply click on the Inherit size from an existing pipe to achieve this.

To select the required angle:-

- Click on the angle you desire as shown on the dialog image or
- Enter the angle in the box supplied or
- If the angle is an unknown you can use the Define by two points button to determine the actual angle you need.

To set the type of pipe joint the user clicks on the desired radio buttons to achieve this.

Once set the values are retained as the default through the editing session.

On selecting OK the dialog closes and the user is prompted in the command line with :-

Centre line start point:

Here the user must indicate the start location point on the drawing screen by moving the cursor and picking a point using the osnap command. Once selected the user is again prompted in the command line with :-

Piping centre line end point:

Here the user can either drag the cursor to the desired location and pick the desired point or he/she can enter the required distance the pipe needs to cover. The pipe will then be drawn with lengths, colours and layers as setup in the configuration section (Explained later in this user manual)

Note: Any inline fitting can then be selected off the ribbon to continue with this run or the user can end the program and start a new duct run by using the icons on the ribbon.



- Pipe elbow

As per the pipe straight section the user will be prompted with the same question:-

Select existing object or Enter to start !!!

Follow the same steps in Dialog Type L and Type M and select the centre line start point.

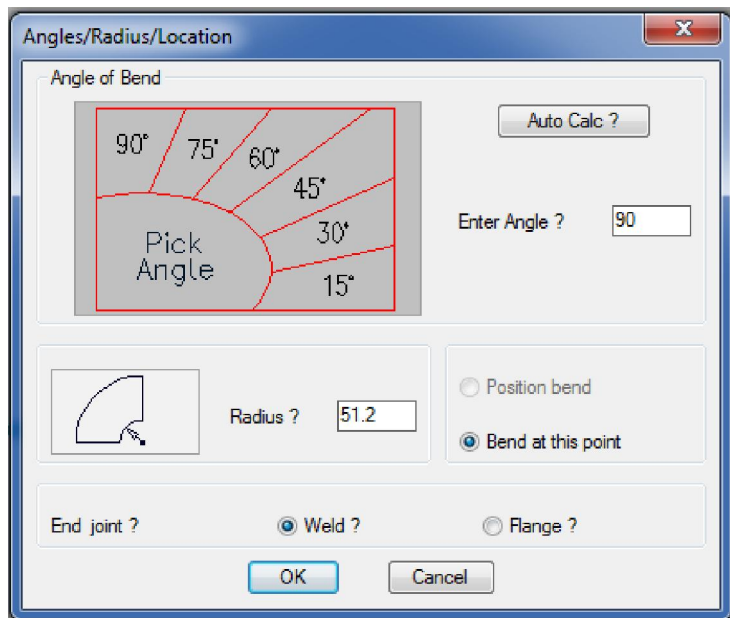

Dialog Type N

To enter the angle of the elbow the user has three options

- By clicking on the angle shown in the image or
- By entering the required angle in the box provided or
- Clicking on the Auto Calc button where the user is requested to pick 2 points for the computer to calculate the desired angle.

The radius of the elbow is defaulted by the software to the Japanese international standard or the user can enter a desired distance in the box provided.

To position the elbow the user can drag the drawn bend into the required location (or enter a distance). There is also the option to just draw the elbow at the point where the command was started.

To set the type of pipe joint the user clicks on the desired radio button to achieve this.

When all the values and items are what the user requires the OK button must be pressed. The elbow will then be drawn with colours and layers as setup in the configuration section (Explained later in this user manual). If the elbow has an angle different to 90 degrees the user will be prompted to position the text indicating that angle.



- Pipe dropper

As per the pipe straight section the user will be prompted with the same question:-

Select existing object or Enter to start !!!

Follow the same steps in Dialog Type L and Type M.

The following dialog will be displayed for the user to enter the radius or to use the default

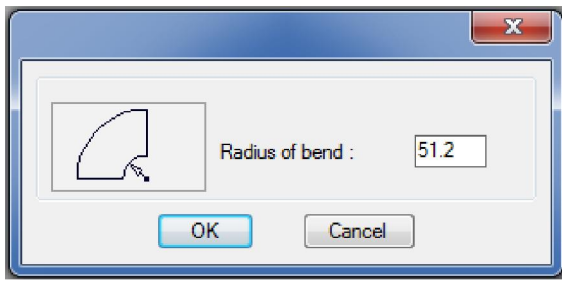

Dialog Type O

When OK is clicked the user pipe dropper will be drawn and the user will be prompted to

Position pipe riser in required location !!!

Move the dropper to the location on the drawing and click the pick button the mouse.

If the dropper was attached to an existing pipe run or was used after inserting a pipe run only dialog type O would appear for the radius to be set and the dropper would be drawn connected to the existing pipe run.



- Pipe riser

Follow the method as shown above for the pipe dropper. The only difference is that the symbol inserted into the drawing shows a cut off section in the elbow.



- Pipe cross section riser

When selecting this option off the HVACPAC ribbon the following dialog will be displayed

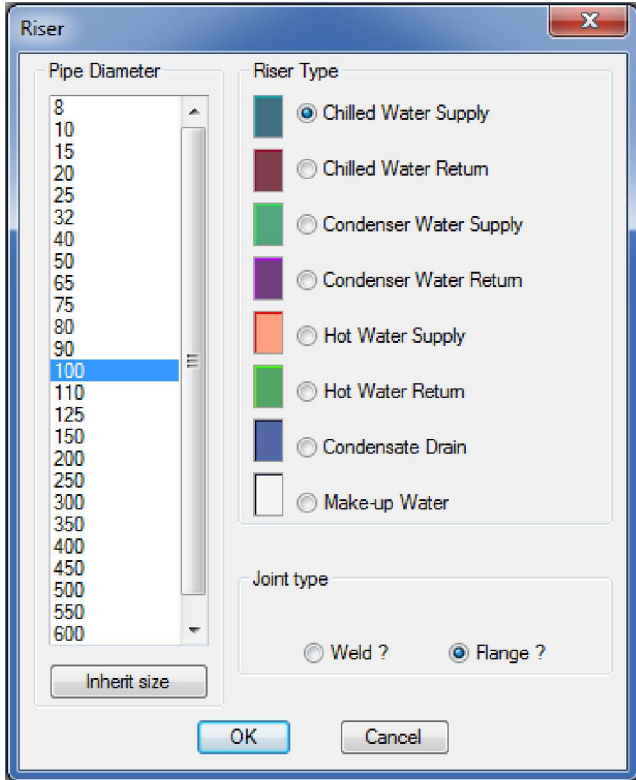

Here the user can select the pipe size from the list, the pipe size and what pipe joint is to be displayed. Once selected and the OK button pressed the pipe riser is drawn and the user can position it on the drawing in the required location.

Note: This cross section riser will not be included in the piping bill.



- Pipe take-off

When selecting this option off the HVACPAC ribbon the user will be prompted to

Indicate pipe to take off from:

If there is no existing HVACPAC pipe run on the drawing this command will have to be cancelled and a pipe run would have to be drawn in order to use this option.

When clicking on an existing pipe run the following dialog will be displayed

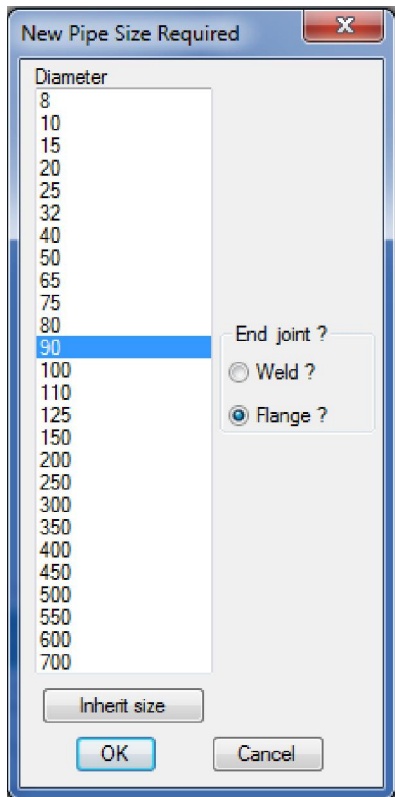

Dialog Type P

Here the user can select the pipe size from the list and what pipe joint is to be displayed. Once selected and the OK button pressed the user will be prompted to

Indicate which side of pipe

The user must click on the side of the pipe where he wants the take-off to attach. The take-off will then be drawn and the user can drag it into position on the existing pipe.

Once positioned the software will cut the existing pipe into two sections and insert the take-off between.



- Pipe stab-in

When selecting this option off the HVACPAC ribbon the user will be prompted to

Indicate pipe to take off from:

If there is no existing HVACPAC pipe run on the drawing this command will have to be cancelled and a pipe run would have to be drawn in order to use this option.

When clicking on an existing pipe run the dialog Type P will be displayed

Here the user can select the pipe size from the list and what pipe joint is to be displayed. Once selected and the OK button pressed the following dialog will be displayed for the user to enter the length of the pipe stab-in

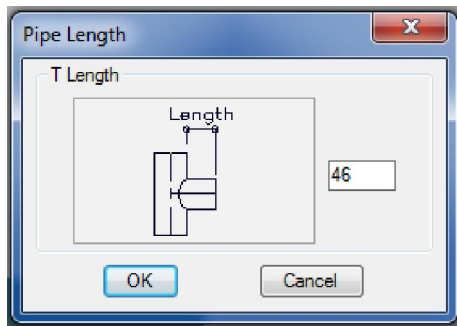

And on clicking OK the user will be prompted to

Indicate which side of pipe

The user must click on the side of the pipe where he wants the stab-in to attach. The stab-in will then be drawn and the user can drag it into position on the existing pipe.



- Pipe drop and continue

As per the pipe straight section the user will be prompted with the same question:-

Select existing object or Enter to start !!!

Follow the same steps in Dialog Type L and Type M and select the centre line start point.

Or click on an existing HVACPAC pipe entity and the software will use that entities settings such as Type, size, direction, etc .

Once initiated the display screen will change to a side view and Dialog Type N will appear to ask the angle of the bend. (Note: No other options on the dialog will work with the dropping pipe sections)

Once the angle has been entered using any of the input methods available the user will be able to drag the displayed elbow into the required position. A depth indicator is shown on the right of the screen to indicate how far the pipe has dropped. Note when this depth is reached and is to the users' satisfaction the pick button must be used and not the amount entered at the command prompt to get the correct depth indicated on the plan view.

Once picked the display screen will return to the plan view and the pipe drop depth will be textually indicated on the layout. The user can then continue with the pipe straight run or choose another option from the ribbon.



- Pipe rise and continue

Note that the rising pipe sections are just a reverse of the dropping duct sections as described above.



- Pipe reducer / enlarger

As per the pipe straight section the user will be prompted with the same question:-

Select existing object or Enter to start !!!

Follow the same steps in Dialog Type L and Type M and select the centre line start point.

Or click on an existing HVACPAC pipe entity and the software will use that entities settings such as Type, size, direction, etc .

Once initiated dialog type P will be displayed

Here the user can select the pipe size from the list and what pipe joint is to be displayed. Once selected and the OK button pressed the following dialog will be displayed

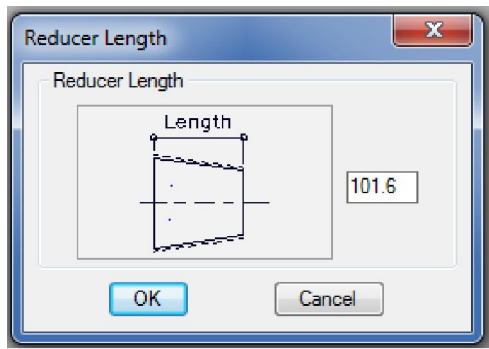

The user can now accept the default length or change by entering his required length in the box provided. When the OK button is pressed the user will be prompted

Indicate which side to reduce to <M>

Here the user can either a) hit the enter button to reduce/enlarge to the middle b) click on the left side of the pipe to reduce/enlarge flat on the left side or c) click on the right side of the pipe to reduce/enlarge flat on the right side



- Flexible pipe connection

As per the pipe straight section the user will be prompted with the same question:-

Select existing object or Enter to start !!!

Follow the same steps in Dialog Type L and Type M and select the centre line start point.

Or click on an existing HVACPAC pipe entity and the software will use that entities settings such as Type, size, direction, etc .

The user will then be asked to indicate the next point. This happens repeatedly until the flexible destination has been met. On clicking the right mouse key the flexible will be indicated with curved segments.

Tip: Turn the ortho mode to off when creating the flexible and pick zig zag points as shown below left this will create the wavy feature below right



- Pipe cut-off

As per the pipe straight section the user will be prompted with the same question:-

Select existing object or Enter to start !!!

Follow the same steps in Dialog Type L and Type M and select the centre line start point.

Or click on an existing HVACPAC pipe entity and the software will use that entities settings such as Type, size, direction, etc .

After selecting the start point the user will be prompted to

Indicate termination endpoint

The pipe will then be drawn to this point and an end termination symbol will be indicated.

Note: This section of piping will not be included in the bill.



- Pipe cut-off both ends

As per the pipe straight section the user will be prompted with the same question:-

Select existing object or Enter to start !!!

Follow the same steps in Dialog Type L and Type M and select the centre line start point.

Or click on an existing HVACPAC pipe entity and the software will use that entities settings such as Type, size, direction, etc .

After selecting the start point the user will be prompted to

Indicate termination endpoint

The pipe will then be drawn to this point and end termination symbol will be indicated on both ends.

Note: This section of piping will not be included in the bill.

Fittings :-



- Valves

When selecting this option off the HVACPAC ribbon the following dialog will be displayed

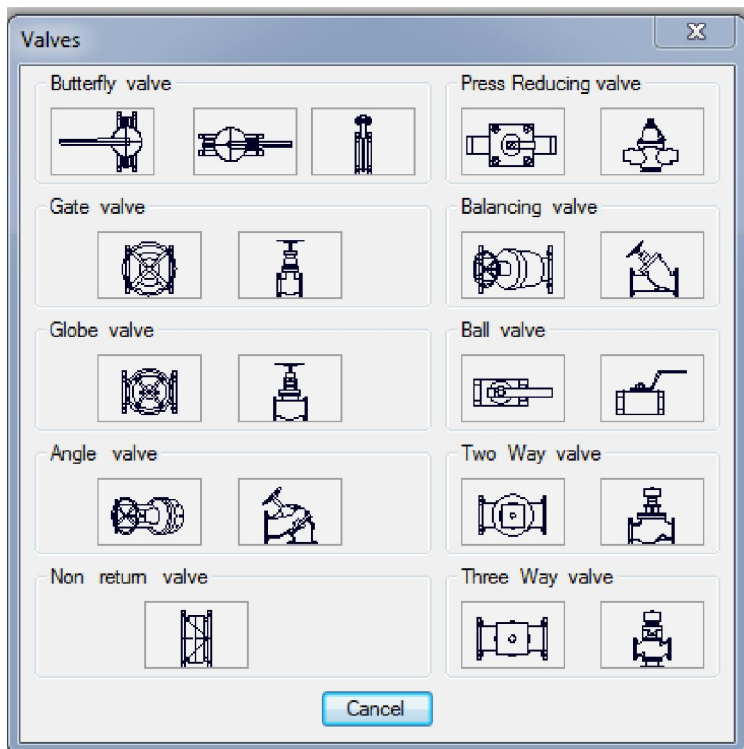

Here the user can select any one of the valves shown in the images to suit his application. Once selected the software returns to the editing section and as per the pipe straight section the user will be prompted with the same question:-

Select existing object or Enter to start !!!

Follow the same steps in Dialog Type L and Type M and select the centre line start point.

Or click on an existing HVACPAC pipe entity and the software will use that entities settings such as Type, size, direction, etc .

After selecting the start point the valve will be drawn and if an existing entity was not picked then the user will be required to indicate the required rotation of the valve.

Note: If a valve is selected and HVACPAC does nothing this means that that type of valve is not available for that pipe size. To correct this reduce the pipe size or select a different valve to be used



- Pipe miscellaneous fittings

When selecting this option off the HVACPAC ribbon the following dialog will be displayed

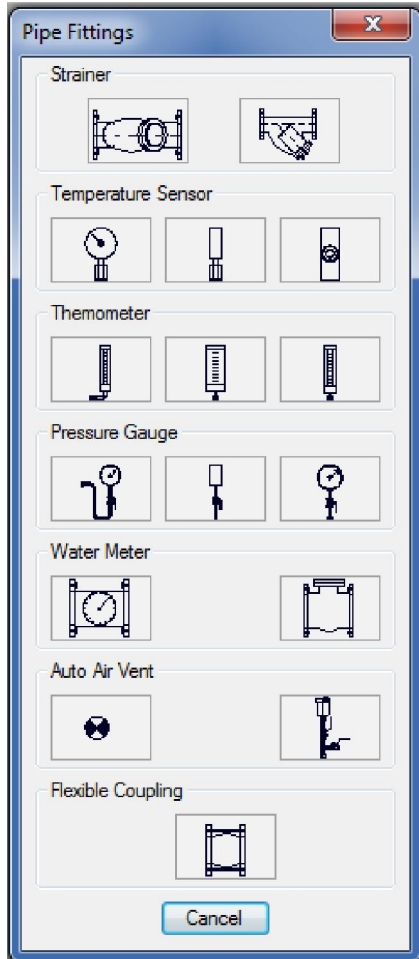

Here the user can select any one of the fittings shown in the images to suit his application. Once selected the software returns to the editing section and if a Strainer, Water meter or a Flexible coupling was picked then as per the pipe straight section the user will be prompted with the same question:-

Select existing object or Enter to start !!!

Follow the same steps in Dialog Type L and Type M and select the centre line start point.

Or click on an existing HVACPAC pipe entity and the software will use that entities settings such as Type, size, direction, etc

Note: This option is compulsory when picking Sensors, thermometers gauges and vents

After selecting the start point the fitting will be drawn and if an existing entity was not picked then the user will be required to indicate the required rotation of the fitting



- Water make-up point

When selecting this option off the HVACPAC ribbon the water make-up symbol will be drawn and the user prompted to

Position water point and then to Position identification text !



- Pipe blank end flange

As per the pipe straight section the user will be prompted with the same question:-

Select existing object or Enter to start !!!

Follow the same steps in Dialog Type L and Type M and select the centre line start point.

Or click on an existing HVACPAC pipe entity and the software will use that entities settings such as Type, size, direction, etc .

After selecting the start point or selecting the existing pipe run a blank end flange will be indicated on the drawing.



- Add remove flanges

When selecting this option off the HVACPAC ribbon the user will be prompted to

Select pipe to add/remove flanges:

When clicking on a pipe that has no flange at the end a flange will be added and visa versa If there is a flange already at the end of the pipe then the software will remove it.



- Full-bore drain point

When selecting this option off the HVACPAC ribbon the full-bore drain point symbol will be drawn and the user prompted to

Position full-bore drain and then to Position identification text !



- Drain point

When selecting this option off the HVACPAC ribbon the drain point symbol will be drawn and the user prompted to

Position drain point and then to Position identification text !

Editing :



Tip: For editing text quickly the user can choose a shortcut key from the keyboard and in either the express tools alias editor or editing the acad.pgp file he can add the command MRTEXT. I use the 1 key and when pressing this I can edit any HVACPAC object that has text attached. You can also tap on dtext, text or dimensions to alter these.



- Edit Text

When selecting this option off the HVACPAC ribbon the user will be prompted with

Select an object with text to be changed :

The following text edit dialog will be displayed

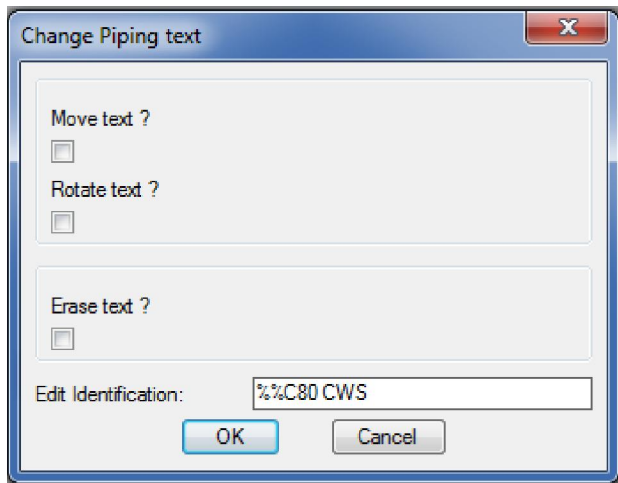

Now using the tick boxes the user can indicate if he wants to move or rotate (or do both) to the piping text. He/she can also erase the piping text.

The user can also change the pipe size. **Please note that if the value is changed it will not be recorded in the bill of quantities, hence the bill will still calculate to the original value. So it is best to redraw the pipe to the correct size for the bill to be accurate.**

When OK is clicked the user can then make the changes as picked in the dialog box.



- Change Text Height, colour, rotation or erase text

When selecting this option off the HVACPAC ribbon the following dialog will be displayed

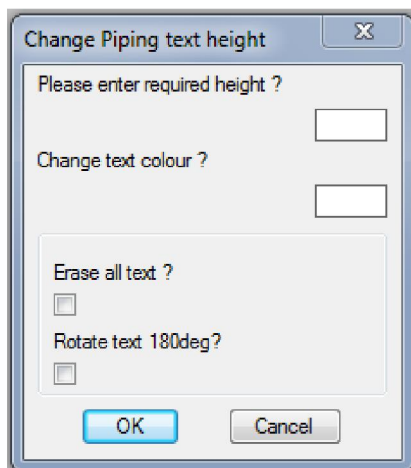

Dialog Type Q

Here the user can enter the new text height or new colour, he/she can also choose to erase all the text or rotate the text through 180 degrees (This rotation is handy when using the HVACPAC mirror command explained later in this user manual)

When OK is clicked the user can then select all the HVACPAC objects he/she wants to alter.

Tip: If the user wants to plot all the piping without the pipe sizes he/she can change the height to 1mm plot the drawing and then change back using the same command to the normal text height.



- Label Item

When selecting this option off the HVACPAC ribbon the user will be prompted with

Select existing entity :

Once selected the following dialog box will be displayed

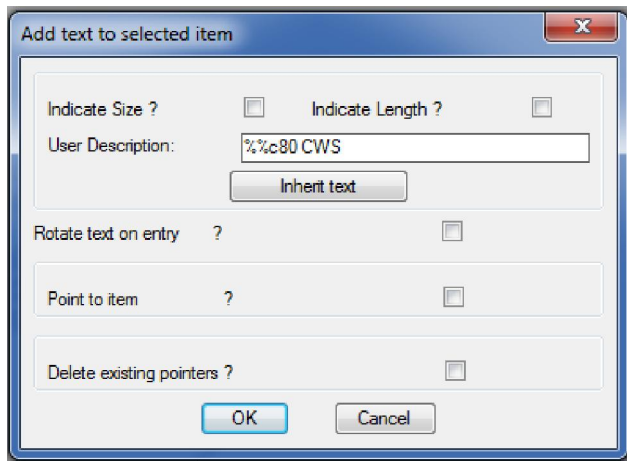

The user can tick the size and length for HVACPAC to display these on a pipe if they had previously been erased. He/she can also add a user description (rotated if need be) to add his/her own words to an entity (Note: The size is commonly used so is defaulted into the box provided but this can easily be removed). The user can also add a pointer to an item or remove a previously added pointer.



- Move text

When selecting this option off the HVACPAC ribbon the user will be prompted to

Select objects:

The user must select all the piping with the text that he wants to have moved to the other side of the pipe.

Note: This is especially handy when there are two pipe runs next to each other and the one run covers the text of the other so this move command will deal with multiple pipes and move all the text equidistant.



- Mirror objects

If the user has mirrored HVACPAC entities with text attached to them (using the AutoCAD mirror command) then he can reverse the text to make it legible by clicking on this icon.

The user is prompted with **Select objects** : when selected and the enter button pressed the text is corrected to be legible. If the text is upside down then the user can use dialog type Q to rotate the text through 180 degrees.



- Hidden lines

When selecting this option off the HVACPAC ribbon the following dialog will be displayed

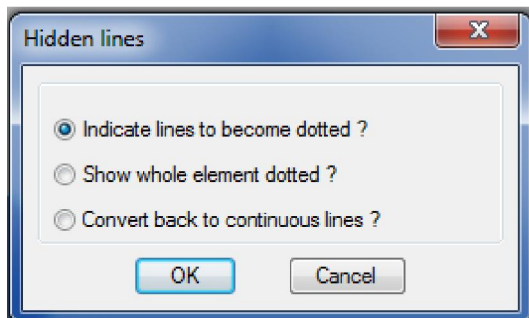

Here the user can select the hidden line option he/she wants.

If he chooses to indicate the lines he/she will be prompted to select the HVACPAC item that must be changed. A pair of scissors is shown at the cursor and the user must select the lines in the entity to cut. Once all the cut points are made the user

must hit the enter button. Now he/she must select the lines in between the cut points that must be changed to hidden line type.

If the option to show the whole HVACPAC item dotted is chosen then the software will convert the objects line type to hidden and visa versa if the option to show the item line types continuous the software will change them back.

Note: This option will not work with 3D elements as they are made up of solids and cannot be cut or changed.



- Lengthen or Shorten existing piping

When selecting this option off the HVACPAC ribbon the user will be prompted to

Select objects:

Once selected the user can drag the pipe to make it shorter or longer.

Miscellaneous :



Miscellaneous



- Piping configuration

Tip: This is an important part of HVACPAC to set up the application to perform to your requirements

When selecting this option off the HVACPAC ribbon the following dialog will be displayed

The dialog box is titled "HVAC PAC Piping Configuration" and contains the following sections:

- Colours:** A list of 18 items with corresponding color swatches:
 - Chilled water supply piping (Cyan)
 - Chilled water supply pipe shading (Dark Cyan)
 - Chilled water return piping (Dark Red)
 - Chilled water return pipe shading (Dark Maroon)
 - Condenser water supply piping (Bright Green)
 - Condenser water supply pipe shading (Dark Green)
 - Condenser water return piping (Purple)
 - Condenser water return pipe shading (Dark Purple)
 - Piping text (Black)
 - Hot water supply piping (Red)
 - Hot water supply pipe shading (Orange)
 - Hot water return piping (Light Green)
 - Hot water return pipe shading (Dark Green)
 - Condensate drain piping (Dark Blue)
 - Condensate drain pipe shading (Medium Blue)
 - Make-up water piping (Dark Blue)
 - Make-up water pipe shading (White)
 - Pipe Insulation (Dark Blue)
 - Pipe Flanges (Dark Blue)
 - Pipe Fittings (Dark Blue)
- Layering Name Setup:** Fields for Piping, Shading, Insulation, Fittings, Flanges, and Text, each with a text input box.
- Shading:** Radio buttons for On/Off.
- Text:** Radio buttons for On/Off.
- Draw 3D:** Radio buttons for Yes/No.
- Piping Text Height ? :** Input field with value 155.
- Piping lengths ? :** Input field with value 6100.
- Insulation Thickness:** Input fields for Pipes 15 to 50 = (25), Pipes 65 to 90 = (38), Pipes 100 to 300 = (38), Pipes >350 = (50).
- Directory Location of Microsoft Excel ? :** Input field with value c:/program files/microsoft office/office12/excel.exe.
- Buttons:** OK, Cancel, Load File, Save File As.

Here the user can configure all the colours and layer names for the different types of piping used in HVACPAC.

Once set the different types of configurations can be saved and loaded when the different settings are required.

The HVACPAC shading can either be turned on or off according to how the user wants his drawing to be displayed.

In the text section of this dialog the text can either be turned on or off and can be sized to suit the plot scale of the drawing.

HVACPAC can do limited 3D work and this can be controlled here if the user wants to do some modelled pipework and equipment.

Insulation thickness can be changed to suit the application and be correctly calculated in the bill. A range of pipes sizes are given so that altering insulation thicknesses can be used.

Finally HVACPAC needs to know where Microsoft Excel resides on your system so that the bill can automatically open up the spread sheet once calculated. This can be done by searching for excel.exe on your system and copying the path into the box provided.

Tip: 2 configuration files are provided with HVACPAC and they are 1-100.p for 1:100 scaled drawings and 1-50.p for 1:50 scaled drawings



- HVACPAC Enquiry

When selecting this option off the HVACPAC ribbon the user will be prompted to

Select existing entity :

And depending on the entity selected the following dialog will be displayed informing the user of the item, type, diameter and the item length.

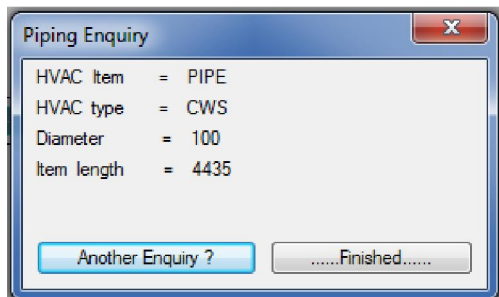

- Bill of quantities

When selecting this option off the HVACPAC ribbon the user will be prompted to

Select objects:

Once selected AutoCAD will open up Microsoft excel and the bill of the separate entities will be displayed on the spread sheet.

Tip: Make sure that the HVACPAC configuration file points correctly to where excel is on your workstation and also make sure that you click on Enable content when excel displays that message

Air Terminals :-

Diffusers :-



Diffusers



- Rectangular constant air volume diffuser

When selecting this option off the HVACPAC ribbon the following dialog will be displayed

Diffusers

Diffuser Information

600

600

Location = BL

Rotate Diffuser ?

No ? Yes ?

Spigot Location:

Location ? Middle

Spigot Size ? 200

Spigot ?

Yes ? No ?

Identification No: 1 Air Quantity l/s ? 200 Elevation ? 0

Air Direction

4wb

Diffuser type

Standard Swirl

Heater

Capacity (kW) ? -

Plenum

Height ? 250

Existing terminals

Identification	Type	Size	Spigot	Heater	Quantity
[Dropdown Menu]					

OK Cancel

Here the user can :

- Enter the plate size of the diffuser
- Indicate the insert point location (by clicking on the dots shown on the diffuser)
- Indicate if the diffuser must be rotated on the drawing
- Indicate the spigot location on the diffuser
- Give the spigot size
- If he/she wants a spigot shown
- Give the diffuser an identification number
- Indicate the diffuser air quantity
- The diffuser elevation if drawing in 3D mode
- Indicate the air direction which will be indicated in the air terminal schedule
- What type of diffuser
- Heater is greyed out here as this is reserved for Variable air volume diffusers
- Indicate the plenum height if the spigot is attached to the side of the unit.

At the base of the dialog there is a table of all the existing diffusers in the drawing if the diffuser he is inserting is typical then all he/she has to do is select the required diffuser and press OK to insert the same terminal.

When OK is pressed the diffuser is drawn according to the inserted information and the user can move it to the required location. If he/she indicated that it should be rotated then the software pauses and awaits the rotation angle from the user. Once located the identification text and air volume text can be positioned next to the diffuser.



- Round Constant air volume diffuser

When selecting this option off the HVACPAC ribbon the following dialog will be displayed

Identification	Type	Size	Spigot	Heater	Quantity
CV01	CAV 4wb	600x 600	200x1	-	2

Here the user can :

- Enter the size of the diffuser plate
- Give the spigot size
- Give the diffuser an identification number
- Indicate the diffuser air quantity
- What type of diffuser
- Heater is greyed out here as this is reserved for Variable air volume diffusers

As per the rectangular diffuser at the base of the dialog there is a table of all the existing diffusers in the drawing if the diffuser he/she is inserting is typical then all he/she has to do is select the required diffuser and press OK to insert the same terminal.

When OK is pressed the diffuser is drawn according to the inserted information and the user can position it on the drawing in the required location. Once located the identification text and air volume text can be positioned next to the diffuser.



- Rectangular variable air volume diffuser

The dialog and procedure for entering the information is identical to the Rectangular constant air volume diffuser above the only difference being that now the user can add a heater capacity and he/she will be prompted to locate the heater isolator next to the diffuser



- Round variable air volume diffuser

The dialog and procedure for entering the information is identical to the Round constant air volume diffuser above the only difference being that now the user can add a heater capacity and he/she will be prompted to locate the heater isolator next to the diffuser



- Variable twist diffuser

When selecting this option off the HVACPAC ribbon the following dialog will be displayed

Variable Twist diffuser

Diffuser Information

Dia 600

Spigot Size ? 200

Identification No: 1 Air Quantity l/s ? 200

Existing terminals

Identification	Type	Size	Spigot	Heater	Quantity
----------------	------	------	--------	--------	----------

OK Cancel

Here the user can :

- Enter the size of the diffuser plate
- Give the spigot size
- Give the diffuser an identification number
- Indicate the diffuser air quantity

As per the rectangular diffuser at the base of the dialog there is a table of all the existing diffusers in the drawing if the diffuser he/she is inserting is typical then all he/she has to do is select the required diffuser and press OK to insert the same terminal.

When OK is pressed the diffuser is drawn according to the inserted information and the user can position it on the drawing in the required location. Once located the identification text and air volume text can be positioned next to the diffuser.



- Linear diffuser

When selecting this option off the HVACPAC ribbon the following dialog will be displayed

Here the user can :

- Enter the size of the Linear diffuser
- Indicate if the diffuser must be rotated on the drawing
- Indicate the spigot location on the diffuser
- Give the spigot size
- If he/she wants a spigot shown
- How many spigots per diffuser
- Give the diffuser an identification number
- Indicate the diffuser air quantity
- Indicate the plenum height if the spigot is attached to the side of the unit.

As per the rectangular diffuser at the base of the dialog there is a table of all the existing diffusers in the drawing if the diffuser he/she is inserting is typical then all he/she has to do is select the required diffuser and press OK to insert the same terminal.

When OK is pressed the diffuser is drawn according to the inserted information and the user can move it to the required location. If he/she indicated that it should be rotated then the software pauses and awaits the rotation angle from the user. Once located the identification text and air volume text can be positioned next to the diffuser.



- Jet nozzle

When selecting this option off the HVACPAC ribbon the following dialog will be displayed

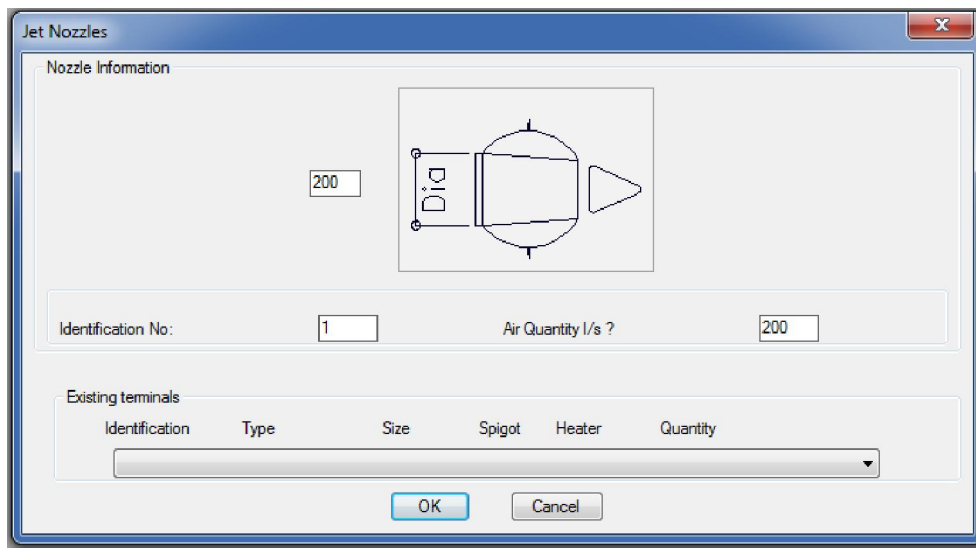

Here the user can :

- a) Enter the size of the jet nozzle spigot connection
- b) Give the diffuser an identification number
- c) Indicate the diffuser air quantity

As per the rectangular diffuser at the base of the dialog there is a table of all the existing jet nozzles in the drawing if the nozzle he/she is inserting is typical then all he/she has to do is select the required nozzle and press OK to insert the same terminal.

When OK is pressed the jet nozzle is drawn according to the inserted information and the user can position it on the drawing in the required location. Once located the identification text and air volume text can be positioned next to the nozzle.

Disc Valves :-



Disc Valves



- Supply Air Disc Valve

When selecting this option off the HVACPAC ribbon the following dialog will be displayed

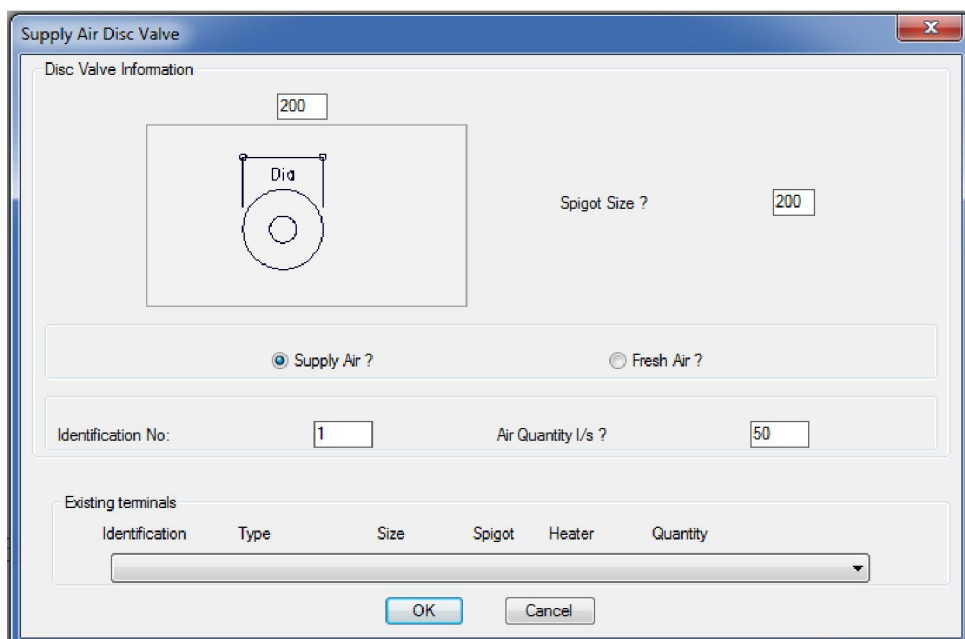

Here the user can :

- a) Enter the size of the disc valve
- b) Enter the size of the spigot connection
- c) Indicate if the disc valve delivers conditioned supply air or fresh air
- d) Give the disc valve an identification number
- e) Indicate the disc valve air quantity

As per the rectangular diffuser at the base of the dialog there is a table of all the existing disc valves in the drawing if the disc valve he/she is inserting is typical then all he/she has to do is select the required disc valve and press OK to insert the same terminal.

When OK is pressed the disc valve is drawn according to the inserted information and the user can position it on the drawing in the required location. Once located the identification text and air volume text can be positioned next to the disc valve.



- Extract Air Disc Valve

When selecting this option off the HVACPAC ribbon the following dialog will be displayed

Identification	Type	Size	Spigot	Heater	Quantity
----------------	------	------	--------	--------	----------

Here the user can :

- a) Enter the size of the disc valve
- b) Enter the size of the spigot connection
- c) Give the disc valve an identification number
- d) Indicate the disc valve air quantity

As per the rectangular diffuser at the base of the dialog there is a table of all the existing disc valves in the drawing if the disc valve he/she is inserting is typical then all he/she has to do is select the required disc valve and press OK to insert the same terminal.

When OK is pressed the disc valve is drawn according to the inserted information and the user can position it on the drawing in the required location. Once located the identification text and air volume text can be positioned next to the disc valve.

Grilles :-



Grilles



- Ceiling Mounted Supply Air Grille

When selecting this option off the HVACPAC ribbon the following dialog will be displayed

Grilles

Grille Information

600

600

Longest side

X

Location = BL

Rotate Grille ?

No ? Yes ?

Spigot Information:

Location ? Top

Spigot Size ? 200

Spigot ?

Yes ? No ?

No off Spigots ?

1 2 3 4

Identification No: 1 Air Quantity l/s ? 50 Elevation ? 0

Grille Type

Eggcrate ? Fixed blade ?

Plenum

Height ? 250

Existing terminals

Identification	Type	Size	Spigot	Heater	Quantity
[Empty table body]					

OK Cancel

Dialog Type R

Here the user can :

- Enter the size of the grille
- Indicate if the grille must be rotated on the drawing
- Indicate the spigot location on the diffuser
- Give the spigot size
- If he/she wants a spigot shown
- How many spigots attached to the grille
- Give the grille an identification number
- Indicate the grille air quantity
- Enter the type of grille to be inserted
- Indicate the plenum height if the spigot is attached to the side of the grille.

As per the rectangular diffuser at the base of the dialog there is a table of all the existing grilles in the drawing if the grille he/she is inserting is typical then all he/she has to do is select the required grille and press OK to insert the same terminal.

When OK is pressed the grille is drawn according to the inserted information and the user can move it to the required location. If he/she indicated that it should be rotated then the software pauses and awaits the rotation angle from the user. Once located the identification text and air volume text can be positioned next to the grille.



- Ceiling Mounted Return Air Grille

When selecting this option off the HVACPAC ribbon dialog box type R will be displayed. The input to the dialog is the same as for the supply air grille the only difference will be the colour and identification of the return air grille.



- Ceiling Mounted Extract Air Grille

When selecting this option off the HVACPAC ribbon dialog box type R will be displayed. The input to the dialog is the same as for the supply air grille the only difference will be the colour and identification of the extract air grille.



- Ceiling Mounted Fresh Air Grille

When selecting this option off the HVACPAC ribbon dialog box type R will be displayed. The input to the dialog is the same as for the supply air grille the only difference will be the colour and identification of the fresh air grille.



- Transfer Air Grille

When selecting this option off the HVACPAC ribbon the following dialog will be displayed

Transfer Air Grilles

Grille Information

600

600

220 2 points Size = 600x600

Identification No: 1 Air Quantity l/s ? 200 Elevation ? 0

Existing terminals

Identification	Type	Size	Spigot	Heater	Quantity
----------------	------	------	--------	--------	----------

OK Cancel

Here the user can :

- Enter the size of the transfer grilles
- Enter the width of the wall between the grilles
- Give the transfer air grilles identification numbers
- Indicate the transfer air quantity
- Give the grilles an elevation

As per the rectangular diffuser at the base of the dialog there is a table of all the existing transfer grilles in the drawing if the grille he/she is inserting is typical then all he/she has to do is select the required grille and press OK to insert the same terminal.

When OK is pressed the transfer air grilles are drawn according to the inserted information and the user can position them on the drawing in the required location. Once located the identification text and air volume text can be positioned next to the transfer air grille.



- Wall Mounted Supply Air Grille

When selecting this option off the HVACPAC ribbon the following dialog will be displayed

Wall mounted return / supply air grille

Grille Information

600

Width

Depth

600

220 2 points Size = 600 x 600

Identification No: 1 Air Quantity l/s ? 50 Elevation ? 0

Existing terminals

Identification	Type	Size	Spigot	Heater	Quantity
----------------	------	------	--------	--------	----------

OK Cancel

Here the user can :

- Enter the size of the grille
- Enter the width of the wall
- Give the grille and identification number
- Indicate the grille air quantity
- Give the grille an elevation

As per the rectangular diffuser at the base of the dialog there is a table of all the existing grilles in the drawing if the grille he/she is inserting is typical then all he/she has to do is select the required grille and press OK to insert the same terminal.

When OK is pressed the grille is drawn according to the inserted information and the user can position it on the drawing in the required location. Once located the identification text and air volume text can be positioned next to the grille.



- Duct Mounted Grilles

When selecting this option off the HVACPAC ribbon the user will be prompted with

Indicate duct to attach to:

Once the duct has been selected the following dialog will be displayed (Note: The side of the duct selected will be the side where the terminal will be placed on)

Here the user can :

- Enter the size of the grille
- Give the grille and identification number
- Indicate the grille air quantity
- Give the grille spigot length
- Indicate whether the grille is on the side of the duct or on the bottom

As per the rectangular diffuser at the base of the dialog there is a table of all the existing grilles in the drawing if the grille he/she is inserting is typical then all he/she has to do is select the required grille and press OK to insert the same terminal.

When OK is pressed the grille is drawn according to the inserted information (Note: The software will automatically display the terminal colours and type of arrows according to the type of duct chosen) and the user can position it on the duct in the required location. Once located the identification text and air volume text can be positioned next to the grille.



- Door Grille

When selecting this option off the HVACPAC ribbon the following dialog will be displayed

Here the user can :

- Enter the size of the grille
- Give the grille and identification number
- Indicate the grille air quantity
- Give the grille an elevation

As per the rectangular diffuser at the base of the dialog there is a table of all the existing grilles in the drawing if the grille he/she is inserting is typical then all he/she has to do is select the required grille and press OK to insert the same terminal.

When OK is pressed the user is prompted to

Indicate doorway midpoints and Opposite doorway midpoint

Once indicated the grille is drawn between the two points according to the inserted information then an air direction arrow is drawn and the software pauses while the user chooses the required direction of the arrow. Once located the identification text and air volume text can be positioned next to the grille.

Louvres :-

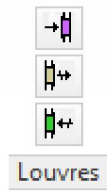

Louvres

- Fresh Air Weather Louvre

When selecting this option off the HVACPAC ribbon the following dialog will be displayed

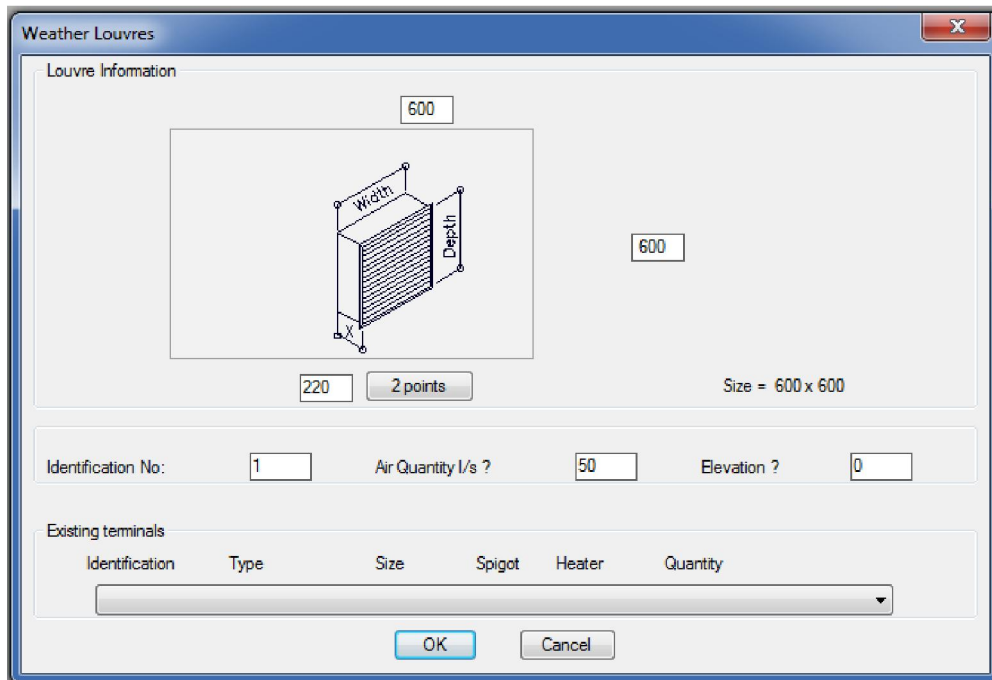

Weather Louvres

Louvre Information

600

Width

Depth

600

220

2 points

Size = 600 x 600

Identification No: 1

Air Quantity l/s ? 50

Elevation ? 0

Existing terminals

Identification	Type	Size	Spigot	Heater	Quantity
----------------	------	------	--------	--------	----------

OK Cancel

Here the user can :

- Enter the size of the louvre
- Enter the width of the wall
- Give the louvre and identification number
- Indicate the louvre air quantity
- Give the louvre an elevation

As per the rectangular diffuser at the base of the dialog there is a table of all the existing louvres in the drawing if the louvre he/she is inserting is typical then all he/she has to do is select the required louvre and press OK to insert the same terminal.

When OK is pressed the louvre is drawn according to the inserted information and the user can position it on the drawing in the required location and then indicate the required louvre angle. Once located the identification text and air volume text can be positioned next to the louvre.

- Exhaust Air Weather Louvre

This option is identical to the fresh air weather louvre above only difference being the colours used to display the louvre.



- Internal Wall Mounted Return Air Louvre

When selecting this option off the HVACPAC ribbon the following dialog will be displayed

Wall mounted return / supply air grille

Grille Information

600

Width

Depth

600

220

2 points

Size = 600 x 600

Identification No: 1 Air Quantity l/s ? 50 Elevation ? 0

Existing terminals

Identification	Type	Size	Spigot	Heater	Quantity
----------------	------	------	--------	--------	----------

OK Cancel

Here the user can :

- Enter the size of the grille/louvre
- Enter the width of the wall
- Give the grille/louvre and identification number
- Indicate the grille/louvre air quantity
- Give the grille an elevation

As per the rectangular diffuser at the base of the dialog there is a table of all the existing grilles in the drawing if the grille he/she is inserting is typical then all he/she has to do is select the required grille and press OK to insert the same terminal.

When OK is pressed the grille/louvre is drawn according to the inserted information and the user can position it on the drawing in the required location and then indicate the required grille/louvre angle. Once located the identification text and air volume text can be positioned next to the grille.

Spigots & Flexibles :



Flexibles



- Spigot and flexible connection

This command can only be used if there is an existing duct present in the editing session. Once selecting this option from the ribbon the following dialog box will be displayed

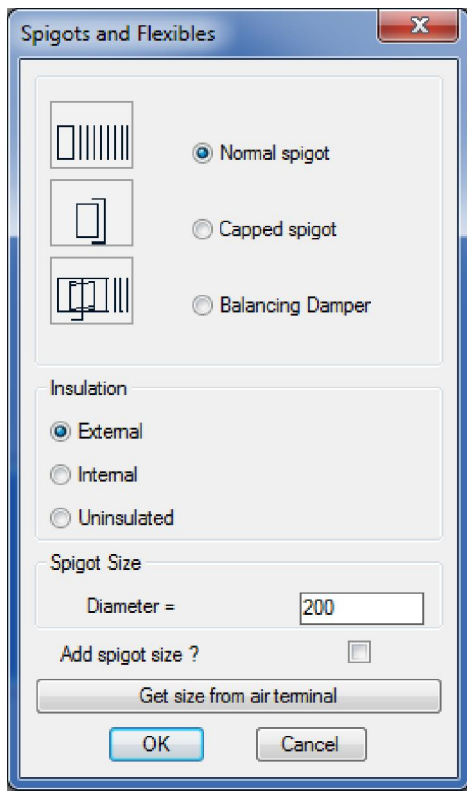

The user has three options for the type of spigot to be indicated on the duct run. All three are indicated as per the insulation and sizes selected in the dialog. The user selects the type of insulation and enters the size of the required spigot. The size can also be inherited from an air terminal (Described later in this user manual). There is also an option to add a size to the spigot when it is inserted.

On clicking the OK button the following prompt will appear and ask the user on which duct to attach to.

Indicate duct to attach to:

Here the user must click on the existing duct. Note it is important to click on the existing duct on the side that you want the spigot to be placed. Once indicated the following prompt is displayed

Position spigot on duct in required location

The user can now drag or enter a distance to position the new spigot onto the face of the existing duct.

If the user selected the :-

- f) Normal spigot option then the user can continue with the flexible duct run by indicating pick points to the required location.
- g) Capped spigot option where the spigot is displayed with a capped off section
- h) Balancing damper option where a damper will be drawn onto the spigot and the user prompted to **Indicate which side to place damper lever** Once selected the user can position the textual identification "BD" next to the damper. If the user presses either the return or enter button he can continue with the duct run and add a flexible by using the method below.



- Extended Spigots

This command also can only be used if there is an existing duct present in the editing session. Once selecting this option from the ribbon the following dialog box will be displayed

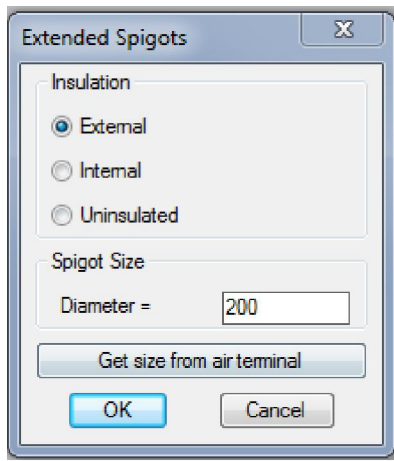

The user selects the type of insulation and enters the size of the required spigot. The size can also be inherited from an air terminal (Described later in this user manual).

On clicking the OK button the following prompt will appear and ask the user on which duct to attach to.

Indicate duct to attach to:

Here the user must click on the existing duct. Note it is important to click on the existing duct on the side that you want the spigot to be placed. Once indicated the following prompt is displayed

Position spigot on duct in required location

The user can now drag or enter a distance to position the new spigot onto the face of the existing duct. Once the spigot is positioned the user can continue with the duct run and then continue with the flexible duct run by indicating pick points to the required location.



- Flexible duct runs

On selecting this option the user will be prompted with the question:-

Select existing object or Enter to start !!!

Click on an existing HVACPAC entity and the software will use that entities settings such as Type, size, direction, etc . or press enter and the following dialog will appear requesting user input for the flexible size and angle

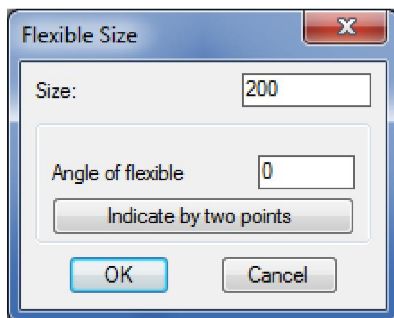

When clicking the OK button the user can draw up the flexible by indicating pick points to the required location.

Editing :



Tip: For editing text quickly the user can choose a shortcut key from the keyboard and in either the express tools alias editor or editing the acad.pgp file he can add the command MRTEXT. I use the 1 key and when pressing this I can edit any HVACPAC object that has text attached. You can also tap on dtext, text or dimensions to alter these.



- Edit Text

When selecting this option off the HVACPAC ribbon the user will be prompted with

Select an object with text to be changed :

The following text edit dialog will be displayed

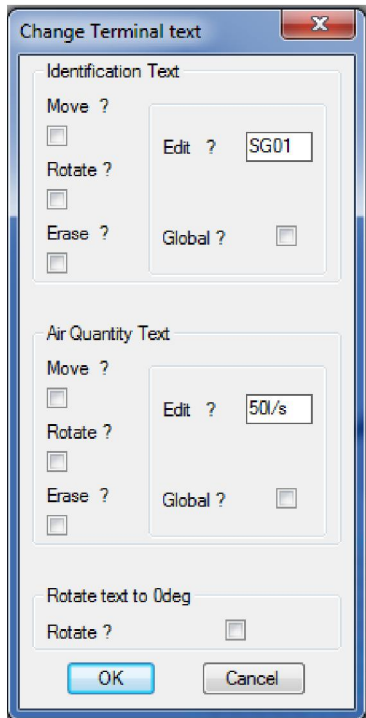

Now using the tick boxes the user can indicate if he wants to move or rotate (or do both) to the terminal text. He/she can also erase the terminal text.

The user can also edit the Terminal identification and air quantity. Note: If the user ticks the global tick box then all grilles with that identification and air quantity will be altered to suit. If not only the edited terminal will change.

There is also an option for the user to rotate the terminal text to zero degrees. This is especially handy when the terminals have been polar arrayed.

When OK is clicked the user can then make the changes as picked in the dialog box.



- Change Text Height, colour, rotation or erase text

When selecting this option off the HVACPAC ribbon the following dialog will be displayed

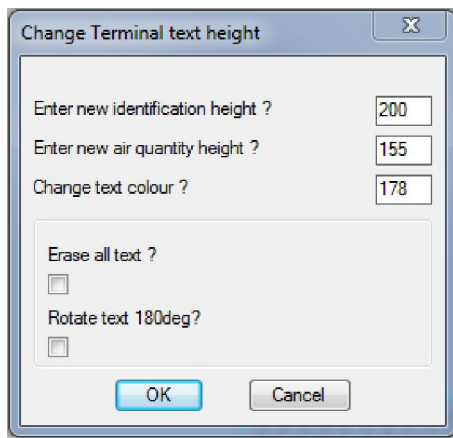

Dialog Type S

Here the user can enter the new text height or new colour, he/she can also choose to erase all the text or rotate the text through 180 degrees (This rotation is handy when using the HVACPAC mirror command explained later in this user manual)

When OK is clicked the user can then select all the HVACPAC objects he/she wants to alter.



- Hidden lines

When selecting this option off the HVACPAC ribbon the following dialog will be displayed

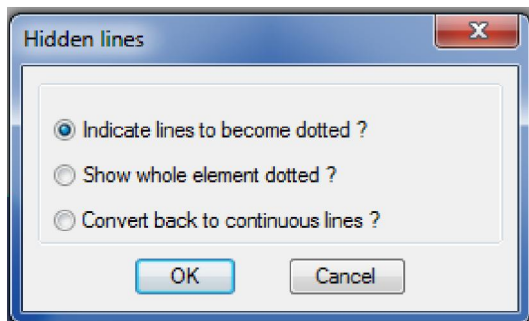

Here the user can select the hidden line option he/she wants.

If he chooses to indicate the lines he/she will be prompted to select the HVACPAC item that must be changed. A pair of scissors is shown at the cursor and the user must select the lines in the entity to cut. Once all the cut points are made the user must hit the enter button. Now he/she must select the lines in between the cut points that must be changed to hidden line type.

If the option to show the whole HVACPAC item dotted is chosen then the software will convert the objects line type to hidden and visa versa if the option to show the item line types continuous the software will change them back.

Note: This option will not work with 3D elements as they are made up of solids and cannot be cut or changed.



- Mirror objects

If the user has mirrored HVACPAC entities with text attached to them (using the AutoCAD mirror command) then he can reverse the text to make it legible by clicking on this icon.

The user is prompted with **Select objects** : when selected and the enter button pressed the text is corrected to be legible. If the text is upside down then the user can use dialog type S to rotate the text through 180 degrees.



- Edit Terminal Electrics

When selecting this option off the HVACPAC ribbon the user will be prompted with

Select Terminal to edit :

Once selected the following dialog will be displayed

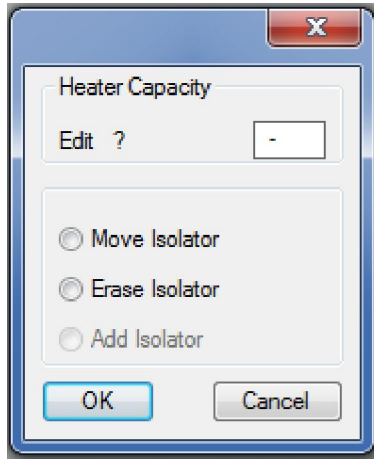

If the terminal has an isolator then the options available in the dialog are to move the isolator or to erase the isolator.

The heater kW capacity can also be added or changed here.

If no isolator is present then the option to move and erase will be greyed out and the option to add an isolator will be available on the dialog.



- Label Item

When selecting this option off the HVACPAC ribbon the user will be prompted with

Select existing entity :

Once selected the following dialog box will be displayed

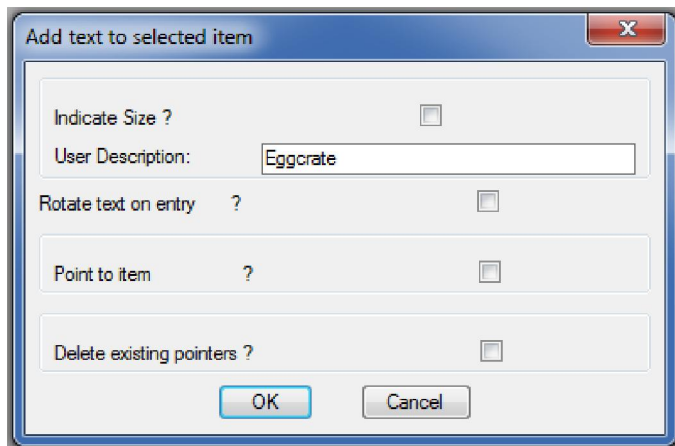

The user can tick the size for HVACPAC to display these on a terminal. He/she can also add a user description (rotated if need be) to add his/her own words to an entity (Note: The type is commonly used so is defaulted into the box provided but this can easily be removed). The user can also add a pointer to an item or remove a previously added pointer.

Miscellaneous :



Miscellaneous



- Terminal configuration

Tip: This is an important part of HVACPAC to set up the application to perform to your requirements

When selecting this option off the HVACPAC ribbon the following dialog will be displayed

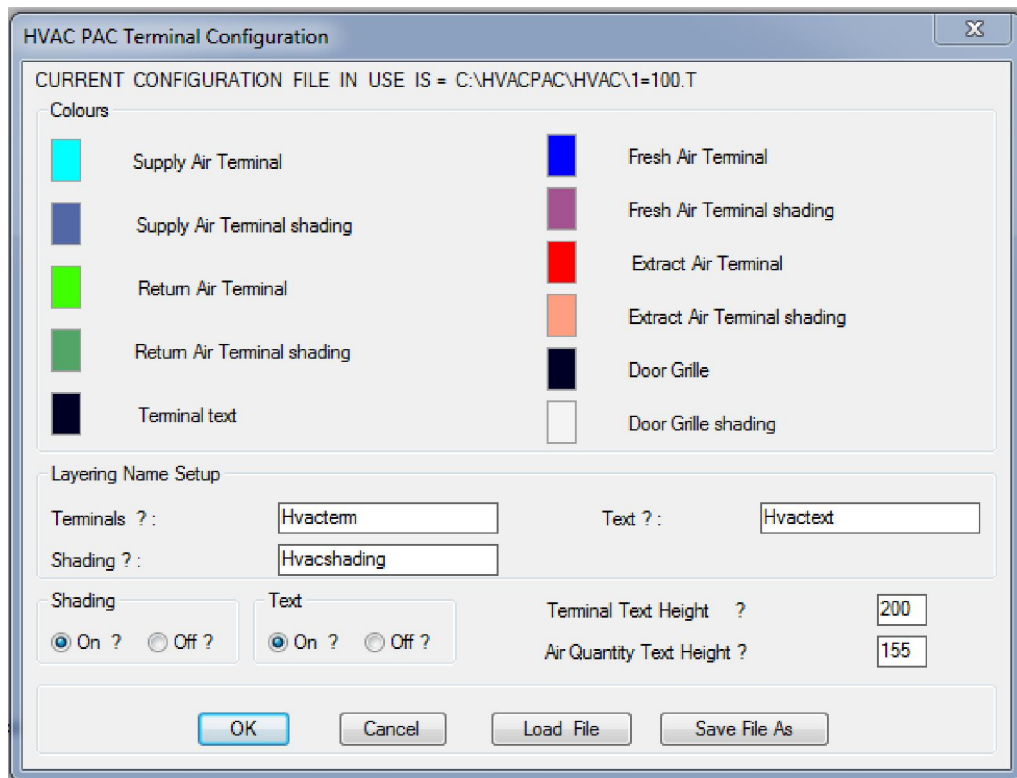

Here the user can configure all the colours and layer names for the different types of terminals used in HVACPAC.

Once set the different types of configurations can be saved and loaded when the different settings are required.

The HVACPAC shading can either be turned on or off according to how the user wants his drawing to be displayed.

In the text section of this dialog the text can either be turned on or off and can be sized to suit the plot scale of the drawing.

Terminal text heights can also be set to the users preference

Tip: 2 configuration files are provided with HVACPAC and they are 1-100.t for 1:100 scaled drawings and 1-50.t for 1:50 scaled drawings



- HVACPAC Enquiry

When selecting this option off the HVACPAC ribbon the user will be prompted to

Select existing entity :

And depending on the entity selected the following dialog will be displayed informing the user of the item ID, type, size, air quantity, spigot size and plenum size

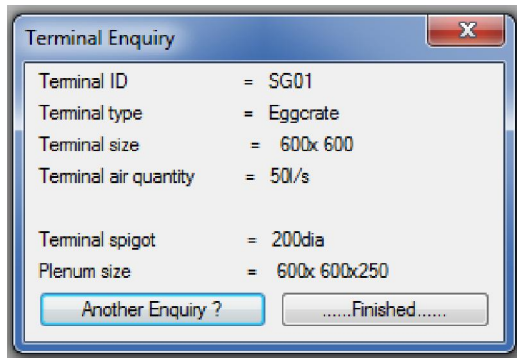

- Air Terminal Schedules

When selecting this option off the HVACPAC ribbon the user will be prompted to

Select objects:

and once he/she have selected the required objects the following prompt will be displayed

Indicate top left point of Terminal Schedule

A schedule of air terminal codes, types, sizes, heater capacity, spigot sizes and quantities will be placed on the drawing at the point indicated by the user.

Tip: Don't worry if fittings or other AutoCAD objects are in the selection window HVACPAC will filter them out of the selection



- Find Terminal

When selecting this option off the HVACPAC ribbon the following dialog will be displayed

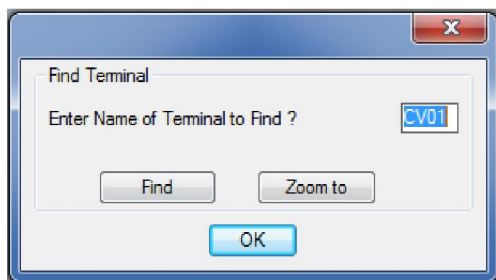

This option is extremely handy when the drawing is cluttered and the user cannot locate a terminal even though the terminal schedule includes it.

The user must enter the terminal identification he is looking for and then press find

The same dialog will display the quantity of air terminals that it located in the drawing. Now to view these the user must click on the zoom to button. HVACPAC will zoom into the first air terminal found and display the following dialog in the top left corner of the display

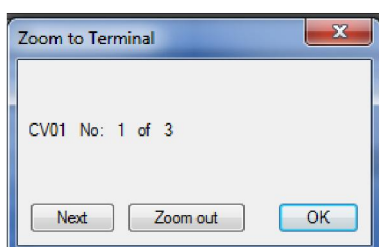

If this is not the terminal that the user is looking for then he/she can press the next button until he has located the terminal he/she is looking for. There is also an option to zoom out where the user can get a better view of where the terminal is located on the drawing.